

Puros Block Allograft Surgical Technique

(continued from previous page)

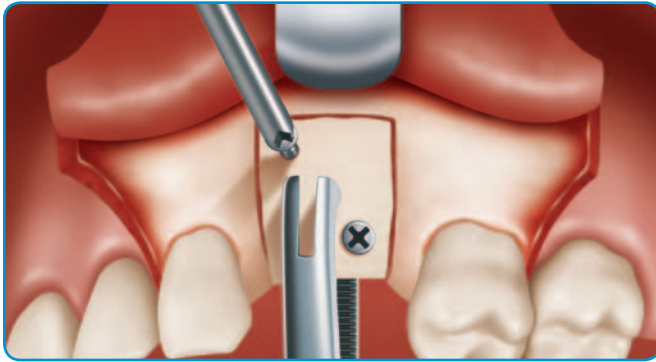

7 Drill and Place Fixation Screws: Secure block graft with clamp. Use a $\varnothing 1.5$ mm bit (lag screw technique), drill oversized hole into block at least ≥ 1 mm from block edge. Next, drill through block into the bony site using a $\varnothing 1.1$ mm bit. Place $\varnothing 1.5$ mm screw of sufficient length through block into pre-drilled hole in the bone; do not secure completely. Repeat for at least one additional screw. Place 2nd screw hole obliquely to the 1st and at least 3mm from 1st screw hole to minimize potential stress fracture. Tighten 2nd screw securely, then go back and tighten the 1st (avoid over-torque). It is recommended that two screws per block graft be placed to prevent rotation. Assure block is stable and free of any sharp corners or edges. **Note: Perforate the cortical layer of the block to encourage revascularization.**

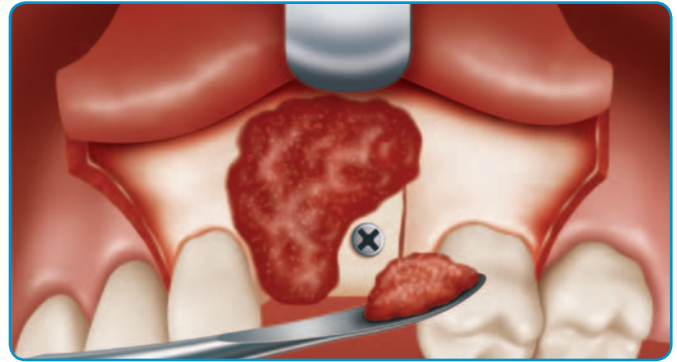

8 Fill Residual Void: Place *Puros* Cancellous Particulate Allograft or *Puros* Demineralized Bone Matrix (DBM) Putty or DBM Putty with Chips around the edges of the block to create a smooth contour to the augmented site.

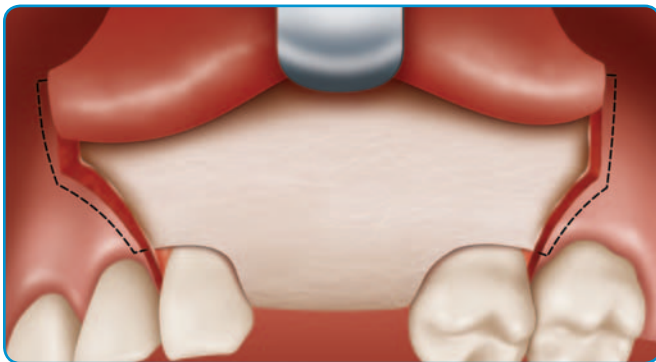

9 Place Membrane: Cover the entire site and extend 2-3mm from all edges with a conformable resorbable membrane such as *Puros* or *CopiOs*® Pericardium Membrane. Secure the membrane with tacks or sutures on both the buccal and labial surfaces. The membrane should lie flat and be closely adapted to the block site.

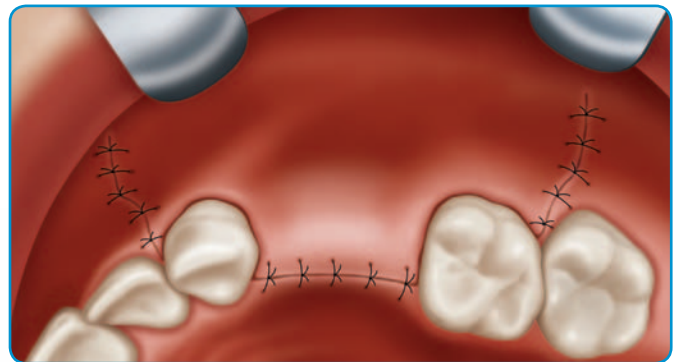

10 Close and Protect: Ensure adequate flap release to achieve tension-free closure and re-approximate soft tissue flap; score periosteum to aid in obtaining closure. Suture with 5/0 or 6/0 monofilament, utilizing an atraumatic needle with an interrupted technique and ensure tension-free primary closure. Start directly over the block site and finish with vertical incisions. Avoid premature loading by utilizing an interim prosthesis over the block site. Allow five to six months for healing to occur.



To learn more about this product, please visit us online at www.zimmerdental.com or to speak to a sales representative, call 1 (800) 854-7019.

For more information about our Products, Regenerative Materials and Educational Opportunities, contact us:

1900 Aston Avenue
Carlsbad, CA 92008-7308
USA

In the U.S. 1 (800) 854-7019
To fax an order 1 (888) 225-2483
Outside the U.S. +1 (760) 929-4300
Australia +61 (0)2 9950 5434 or 1 (800) 241-916
Canada +1 (905) 567-2073 or 1 (800) 265-0968
China +86 21 2211 5147

France +33 (0)1 45 12 35 35
Germany +49 (0)761 1 56 47 0
Israel +972 (0)3 6124242
Italy +39 043 855 5573
Spain +34 93 846 05 43

To receive our eNews visit us at http://www.zimmerdental.com/news_eNewsLetterSignUp.aspx



www.zimmerdental.com



Puros®
Block
Allograft

Changing the concept
of block grafting.



Surgical Technique Guide



zimmer | dental

Puros Block Allograft Surgical Technique



1 Patient Selection: Ensure that patient receiving the block graft is healthy and will be compliant with the proper hygiene and follow-up requirements. In addition, ensure that you have adequate access to perform all surgical steps.



2 Hydrate Block Graft: Once the correct size of block to be utilized has been determined, open the package, and using a sterile technique place the block graft into room temperature 0.9% sterile saline solution for up to 30 minutes. The block graft will initially float in the saline solution.
Note: When block descends to the bottom of the basin, this signals rehydration has occurred.

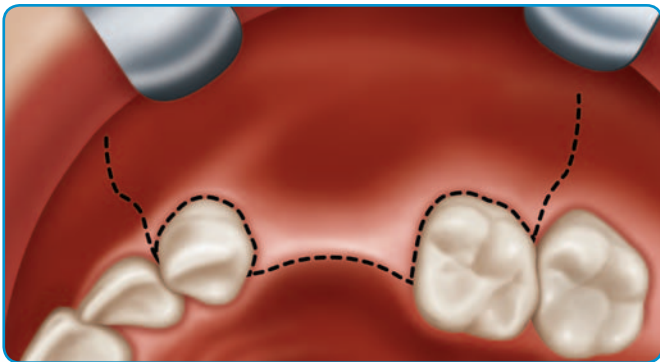

3 Design Incision: Make a full-thickness incision that extends at least one tooth mesial and distal to block implantation site. If necessary, make a releasing incision to allow sufficient tissue and ensure tension-free closure. Make sure the vertical incision is not on top of the joint between the host bone and block graft.

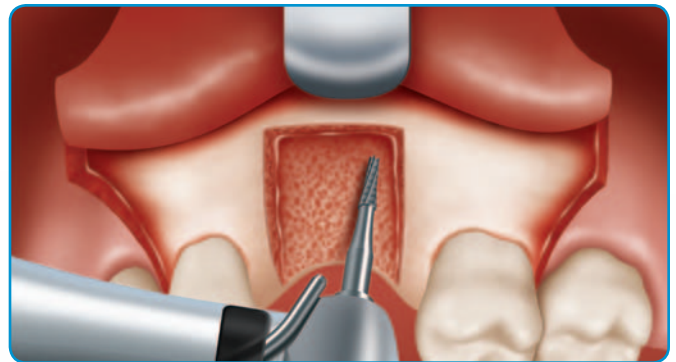

4 Prepare Receptor Site: Prepare a definitive inlay site for block graft placement using a straight bur. Rectangular inlay site should have flat sides and base, with a minimum depth of 0.5mm. Avoid adjacent teeth.



5 Shape Block Graft: Trim block to fit sequentially until the graft lays flat and intimately approximates bony receptor site. Flatten the cancellous side of block graft and do not remove the cortical layer. Carefully round any sharp edges to minimize soft tissue trauma. Utilize a straight bur with irrigation and grasp the block with adequate pressure.
Note: Be careful not to damage or compress the block.

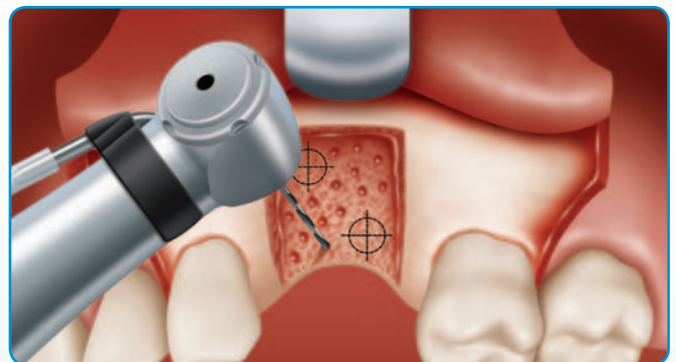

6 Decorticate: Perforate the receptor site with a $\varnothing 1.1$ mm drill or round bur, avoiding areas where the fixation screws will be placed. Ensure that bleeding occurs.

(continued on next page)



Puros Block Allograft Technique Tips.

THE FOLLOWING POINTS ARE SUGGESTED TO HELP ACHIEVE A SUCCESSFUL CLINICAL RESULT:

- Careful patient selection and reinforcement of patient compliance, especially in the posterior jaw, are highly recommended. Do not try to overbuild the ridge in relationship to existing ridge diameters.
- Fully hydrate the block graft with 0.9% sterile saline solution.
- Extend the full-thickness incision beyond the graft site at least one tooth bilaterally. Releasing incisions should be used to assure adequate visualization and tension-free closure. A full-thickness flap is needed to assure adequate soft tissue availability.
- Ensure there is enough source of vascularity from the host bone to ensure vascular access to the block.
- Make sure there are no sharp edges to prevent puncture of the soft tissues.
- Perforate the receptor site to enhance peripheral blood flow to the block graft.
- Ensure intimate contact when mortising the block graft into the receptor site.
- Drill the holes in the block graft the same size as the screw diameter to prevent block fracture. Use of two screws per block graft is recommended.
- Stagger the screws obliquely in the block graft to minimize stress fracture. Allow at least 3mm spacing between each screw hole and at least 1mm from the edge of the block graft.
- Tension-free closure is imperative to avoid soft tissue dehiscence. Atraumatic needle and 5-0 sutures with an interrupted technique is recommended.
- Prevent premature loading until complete healing has occurred.
- Allow adequate healing time (typically 5-6 months) before implant placement.

Ordering Information

Catalog Number	Description
8220	Puros Block Allograft, 10mm
8221	Puros Block Allograft, 15mm

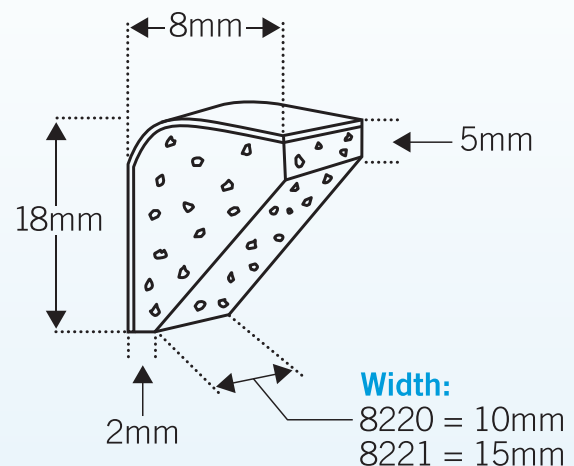

Note: Due to the nature of this material, small variability in color and/or dimensions may occur.

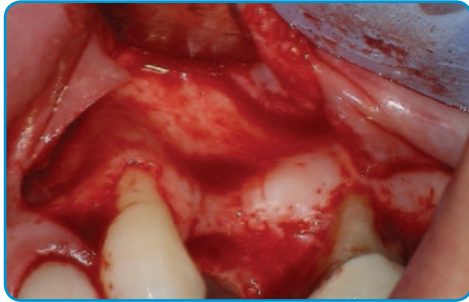

Figure A Preoperative: ridge defects.

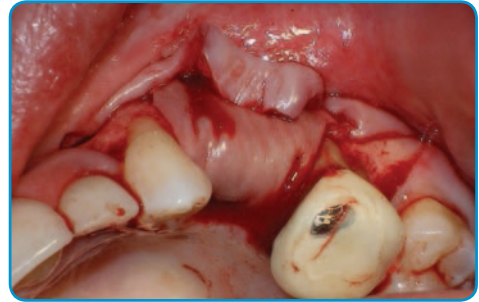

Figure E Puros Pericardium Membrane placed over particulate.

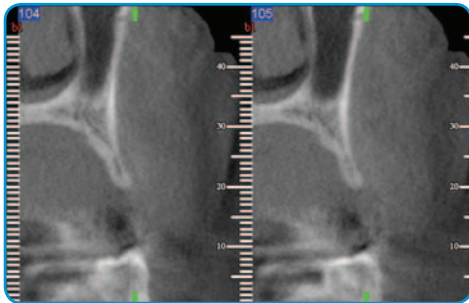

Figure B Pre-operative CT Scan.

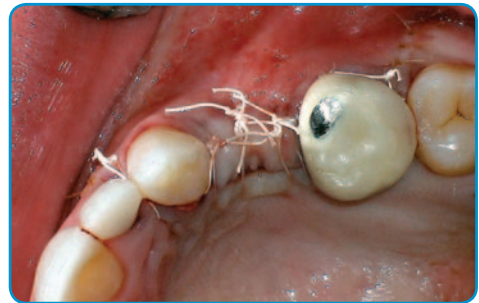

Figure F Membrane sutured in place.



Figure C Puros Block Allograft in place.

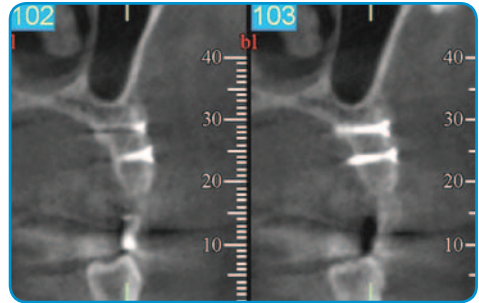

Figure G Post-operative CT Scan.



Figure D Puros Particulate Allograft placed over block.



Figure H Finalized case.

Clinical photos ©2012 Dr. Gregory J. Conte, DMD, MS.
All rights reserved. Individual results may vary.