



Tapered Screw-Vent® and AdVent® Restorative Manual



Partially and Fully Edentulous



zimmer | dental
Confidence in your hands™

Zimmer Dental – Partially Edentulous – Manual – Fully Edentulous – Partially Edentulous – Fully Edentulous



Abutment for cemented crown

Implant-supported prosthesis

- The prosthesis is removable only by the dentist.
- Interdigitates with the implant's hex for anti-rotational stability.
- Forms a friction-fit that virtually eliminates the major causes of screw loosening.
- Prosthetic design should reflect cosmetic and hygiene considerations.
- Provides restorative ease and flexibility with *Hex-Lock Contour*, *Hex-Lock*, Angled and "Cast-To" Gold Abutment options.



Abutment for screw-retained crown or combined post & crown

Implant-supported prosthesis

- The prosthesis is removable only by the dentist.
- Interdigitates with the implant's hex for anti-rotational stability.
- Forms a friction-fit that virtually eliminates the major causes of screw loosening.
- Prosthetic design should reflect cosmetic and hygiene considerations.
- Provides options for screw-retained crown and combined post & crown.
- Abutment type: "Cast-To" Gold Abutment.



Abutment for fixed partial dentures

Implant-supported prosthesis

- The prosthesis is removable only by the dentist.
- Interdigitates with the implant's hex for anti-rotational stability.
- Forms a friction-fit that virtually eliminates the major causes of screw loosening.
- Prosthetic design should reflect cosmetic and hygiene considerations.
- Provides restorative ease and flexibility with *Hex-Lock Contour*, *Hex-Lock*, Angled and "Cast-To" Gold Abutment options.



Abutment for screw-retained fixed partial denture

Implant-supported prosthesis

- The prosthesis is removable only by the dentist.
- Prosthetic design should reflect cosmetic and hygiene considerations.
- Abutment types: Tapered Abutment, Non-Engaging Gold Abutment or *AdVent* Bar Copings.

Table of Contents

General Information

Overview	1
Restorative Options	2
Surgical Procedures and Healing Components	4
Selecting Abutments	6
Abutment Flowchart	8

Restorative Procedures

Indirect or Closed-Tray Transfer Technique	12
Direct or Open-Tray Transfer Technique	15
Immediate Impression Transfer Technique	18
<i>Hex-Lock™</i> Plastic Temporary Abutments	20
<i>Hex-Lock</i> Contour Abutment System	26
<i>Hex-Lock</i> Abutment System	32
Angled Abutment System	40
“Cast-To” Gold Abutment System, Engaging	52
<i>PureForm™</i> Ceramic System	60
Tapered Abutment System	68
<i>Locator®</i> Overdenture Attachment System	80
Ball Abutment System	86
Immediate Bar Fabrication	96
Non-Engaging Gold Abutment System	104

Information

Prosthetic Armamentaria and Auxiliary Components	109
--	-----

*Note: Images shown in the catalog may not be to scale.

Figure 1

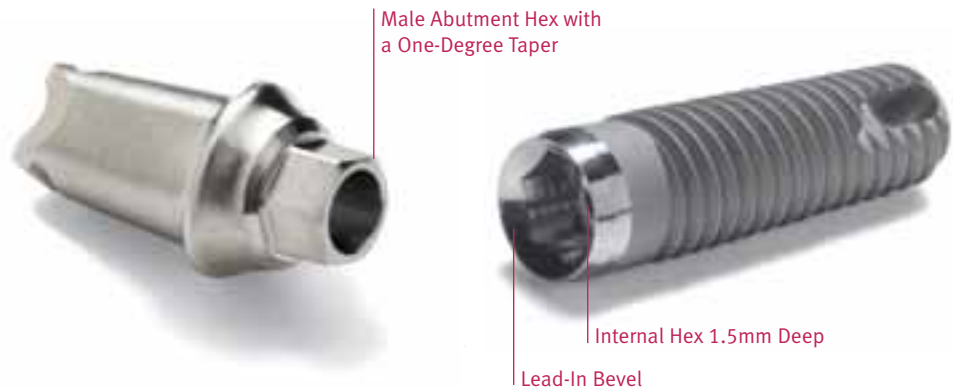

The Prosthetic Products Manual for *Tapered Screw-Vent* and *AdVent* product lines is designed to provide a detailed overview of the prosthetic procedures applicable to these implant systems. It also applies to prosthetics used for *Screw-Vent*® Implants that feature the proprietary internal hex with friction-fit connection.

Overview of the internal hex with friction-fit connection

Abutments for the internal hex implants have a male hex that tapers one degree from the base of the abutment body to the bottom of the hex (Figure 1). As the abutment is seated into the implant under applied torque, the abutment hex frictionally engages the walls of the implant's internal hex. The result is a friction-fit that virtually eliminates rotation between components. Scanning Electron Micrographs reveal the intimate fit that results in a virtual "cold weld" of components (Figures 2, 3).

- 1.5mm deep internal hex distributes forces deeper within the implant, minimizing stress concentrations.
- Lead-in bevel improves ability to seat the abutment properly (Figure 1).
- Connection virtually eliminates rotational micromovement, tipping and effects of occlusal vibration on the abutment, the leading causes of screw loosening.
- Low profile of the internal connection improves esthetics and allows for a better emergence profile.
- Once the friction-fit is established, abutments can only be unseated from the implant with a special Abutment Removal Tool (Figure 4).
- Three prosthetic platforms are available for *Tapered Screw-Vent* Implants: 3.5mmD, 4.5mmD and 5.7mmD, and two *AdVent* prosthetic platforms: 4.5mmD and 5.7mmD.
- Components of both 5.7mmD platforms are cross-compatible. The 4.5mmD platform components are not.



Figure 2 - SEM at 50X magnification shows intimate contact of the internal hex implant at both the beveled implant/abutment interface and the hexagonal engagement area.



Figure 3 - SEM at 150X magnification displays the mechanical interlock in the hexagonal engagement area between the flats of the implant and abutment.

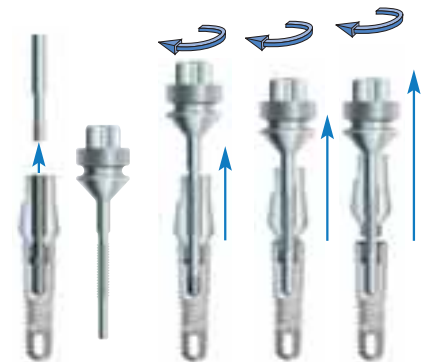

Figure 4 - To remove a fully seated friction-fit abutment from the implant, the abutment screw must first be unthreaded and removed from the abutment body. An Abutment Removal Tool [TLRT2] is then threaded through the abutment and into the implant. As the tool continues rotating, it will disengage the friction-fit connection and gently lift the abutment body off of the implant.



Screw-retained denture

Implant-retained, implant-supported prosthesis

- This prosthesis is recommended primarily for the mandible.
- The prosthesis is removable only by the dentist.
- The secure fit offers the psychological advantage of a fixed prosthesis.
- Five to six implants are preferred for the mandibular prosthesis.
- Six to ten implants are preferred for the maxillary prosthesis.
- Prosthetic design should reflect cosmetic and hygiene considerations.
- Abutment types: Tapered Abutment, Non-Engaging Gold Abutment or *AdVent* Bar Copings.



Bar overdenture

Implant-retained, implant-supported prosthesis

- This prosthesis is recommended for the maxilla and mandible.
- The overdenture is removable by the patient to facilitate hygiene and eliminate stress on the implant/prosthetic system when removed.
- The overdenture is stable and feels natural to the patient.
- Four to six implants are preferred for the mandibular prosthesis.
- Six to ten implants are preferred for the maxillary prosthesis.
- Various attachments are used to affix the denture to the bar.
- Abutment types: Tapered Abutment, Non-Engaging Gold Abutment or *AdVent* Bar Copings.



Ball bar overdenture

Implant-retained, tissue-supported prosthesis

- This prosthesis is recommended primarily for the mandible.
- The overdenture is removable by the patient to facilitate hygiene and eliminate stress on the implant/prosthetic system when removed.
- Slight prosthetic movement, but is stable and feels natural to the patient.
- Four implants are preferred for the Ball Bar Overdenture.
- Abutment types: Tapered Abutment, Non-Engaging Gold Abutment or *AdVent* Bar Copings. *Locator* Bar Attachments and Castable ball patterns also available.



Ball abutment or Locator abutment overdenture

Implant-retained, tissue-supported prosthesis

- This prosthesis is recommended primarily for the mandible.
- The overdenture is removable by the patient to facilitate hygiene and eliminate stress on the implant/prosthetic system when removed.
- Denture movement is necessary, due to the limited number of implants.
- Retained by Ball Abutments or *Locator* Abutments on two implants.
- Two implants are required for a Ball Abutment or *Locator* Abutment Overdenture.
- Abutment type: Ball Abutment, *Locator* Abutment.

Submerged (two-stage) surgical protocol

The submerged surgical protocol is the traditional method of placing root-form dental implants. Two-stage implant designs come preattached to a fixture mount, and are presterilized in double-vial packaging. After the implant is placed, the fixture mount is removed and a low-profile Titanium Surgical Cover Screw is threaded into the top of the implant. The soft tissue is then sutured over the implant, which remains submerged until osseointegration is achieved. A second surgery is then performed to expose the top of the implant. At this time, the cover screw is removed and a transmucosal Healing Collar is attached to the implant. Healing Collars are available in 3mm, 5mm and 7mm lengths, and in diameters of 3.5mm, 4.5mm, 5.5mm, and 6.5mm. The soft tissue is sutured around the Healing Collar and allowed to heal. Once the peri-implant soft tissue sulcus has formed, prosthetic procedures are initiated by removing the Healing Collar to gain access to top of the implant.

Placing a Healing Collar at the second-stage surgery

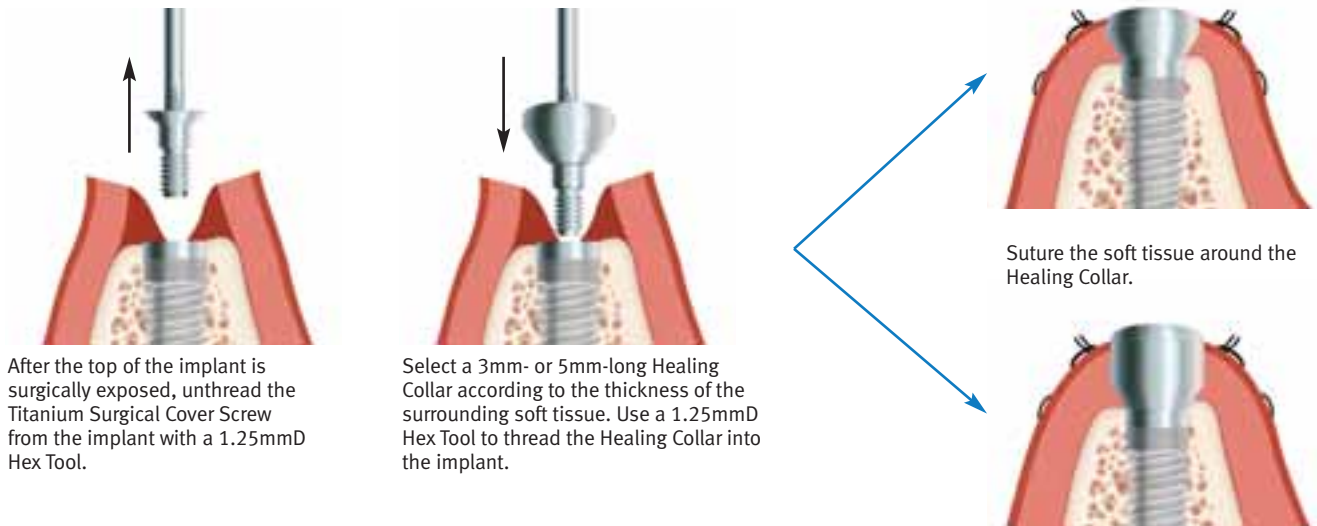

Non-submerged (one-stage) surgical protocol

The one-stage surgical protocol eliminates the implant-uncovering, second-stage surgery mentioned above. The *AdVent* Implant features a 3mm high machined neck which in standard implant placement is supracrestal. If clinical conditions warrant it, the implant can also be placed with up to 2mm of its machined neck subcrestal to allow for either an esthetic type restoration or to accommodate for variations in soft tissue height or prosthesis fabrication.

Included with the implant is an Extender [AVE or AV6E] which can be used to maintain soft tissue opening when the top of the implant is placed subgingival. It can also be utilized with select bar overdenture components (only 4.5mmD platform) to provide a variety of abutment height options.

Placing a healing component at the first-stage surgery

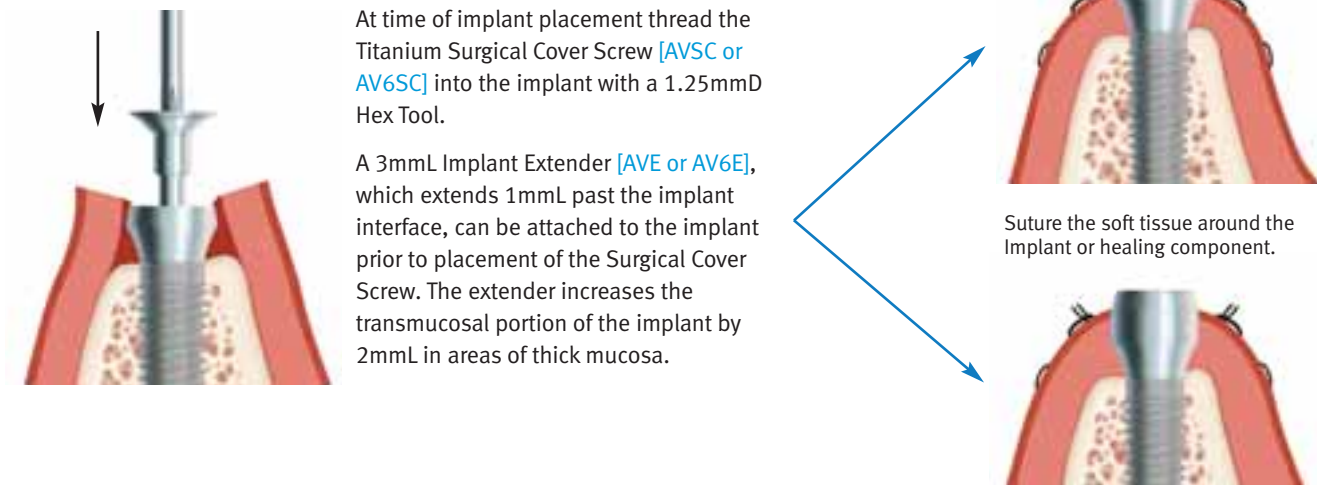

Healing Collars for Tapered Screw-Vent and Screw-Vent Implants

3.5mmD Platform

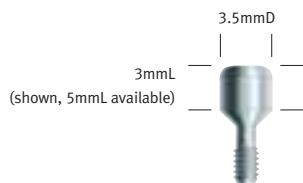

THC3/3
THC5/3



THC3/4
THC5/4
THC7/4

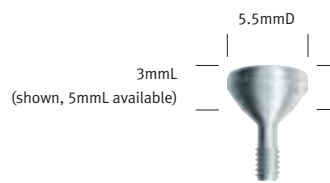

THC3/5
THC5/5

4.5mmD Platform

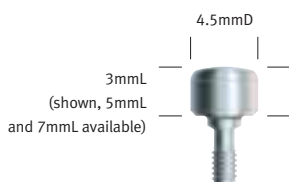

THCW3/4
THCW5/4
THCW7/4



THCW3/5
THCW5/5

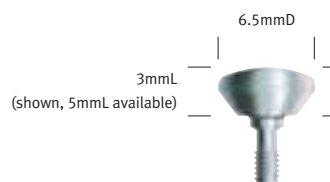

THCW3/6
THCW5/6

5.7mmD Platform*



TH5C3/6
TH5C5/6

*Note: 5.7mmD platform components are also compatible with *AdVent* 5.7mmD platform.

Implant Extender for AdVent Implants with 4.5mm and 5.7mm platform diameters

4.5mmD and 5.7mmD Platform Diameter

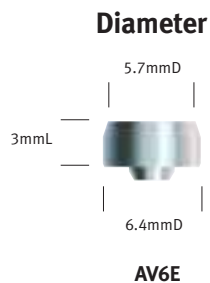
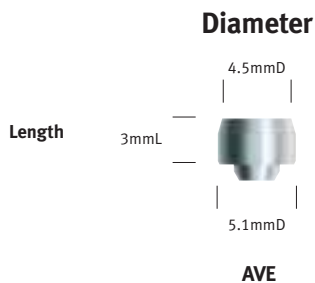

“Cement-to” and screw-receiving abutment systems

All hex-engaging abutments achieve a friction-fit with the implant, regardless of the implant’s design or type of connection. The abutments are assemblies that consist of a one or two-piece abutment body and an abutment screw. The base of the abutment body contains an external hex that interdigitates with the mating internal hex of the implant. This engagement prevents rotation when the abutment screw is threaded into the implant. To complete seating and fully engage the friction-fit, the abutment screw must be tightened to 30 Ncm. These components require the Removal Tool [TLRT2] to assist in the removal of the hex-engaging component from the implant once the abutment screw has been removed.

All non-engaging components consist of a one-piece base with an Abutment Screw [NEA3G and NEA4G] or an abutment body and screw machined in one piece, commonly referred to as a One-Piece Abutment [TAC series and BAC series]. These components do not engage the hex of the implant and can only be used for multiple-unit splinted restorations or attachment overdentures.

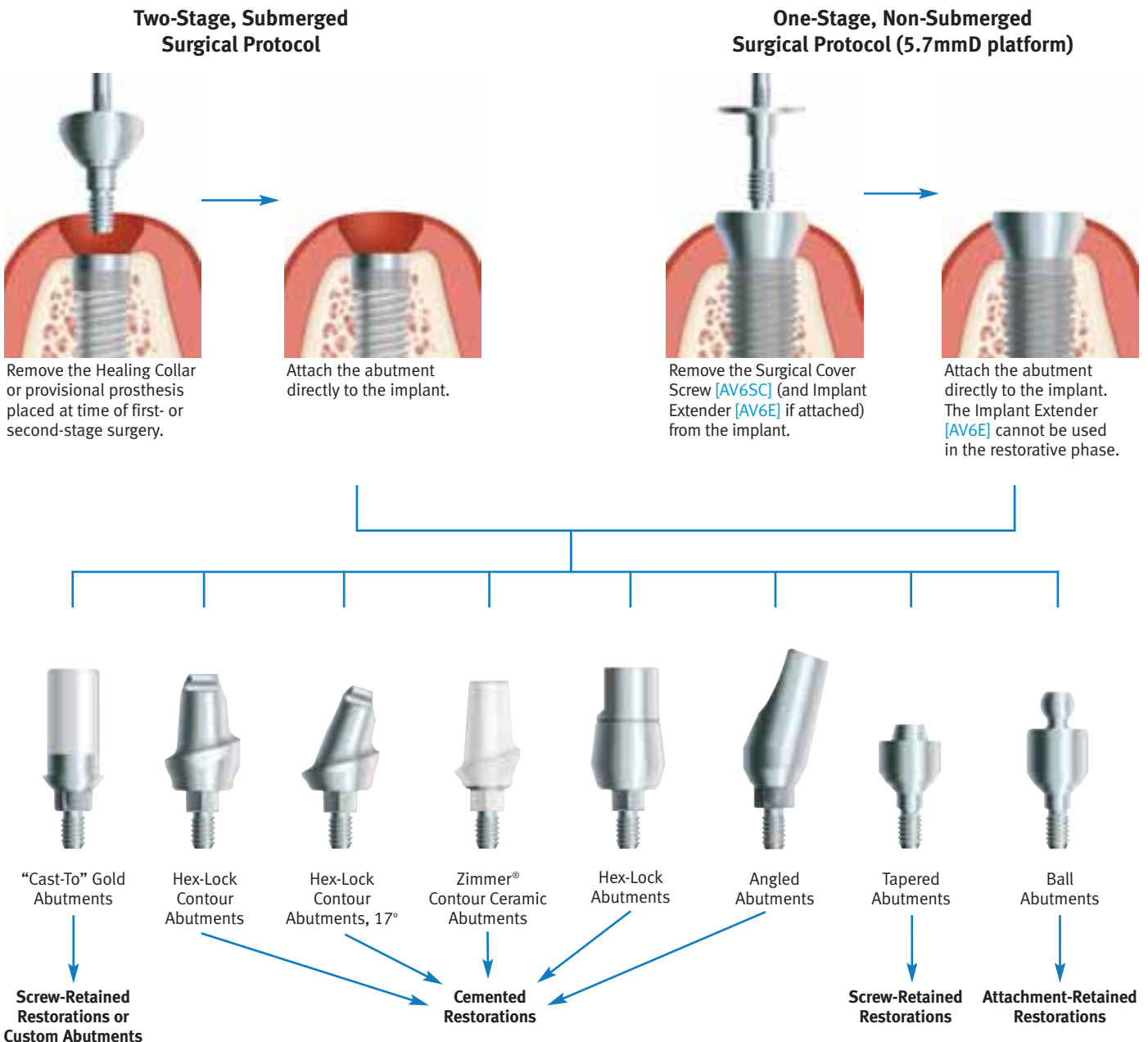

“Cement-to” and screw-receiving abutment systems

All hex-engaging abutments achieve a friction-fit with the implant. The abutments are assemblies that consist of a one- or two-piece abutment body and an abutment screw. The base of the abutment body contains an external hex that interdigitates with the mating internal hex of the implant. This engagement prevents rotation when the abutment screw is threaded into the implant. To complete seating and fully engage the friction-fit, the abutment screw must be tightened to 30 Ncm. These components require the Removal Tool [TLRT2] to assist in the removal of the hex-engaging component from the implant once the abutment screw has been removed.





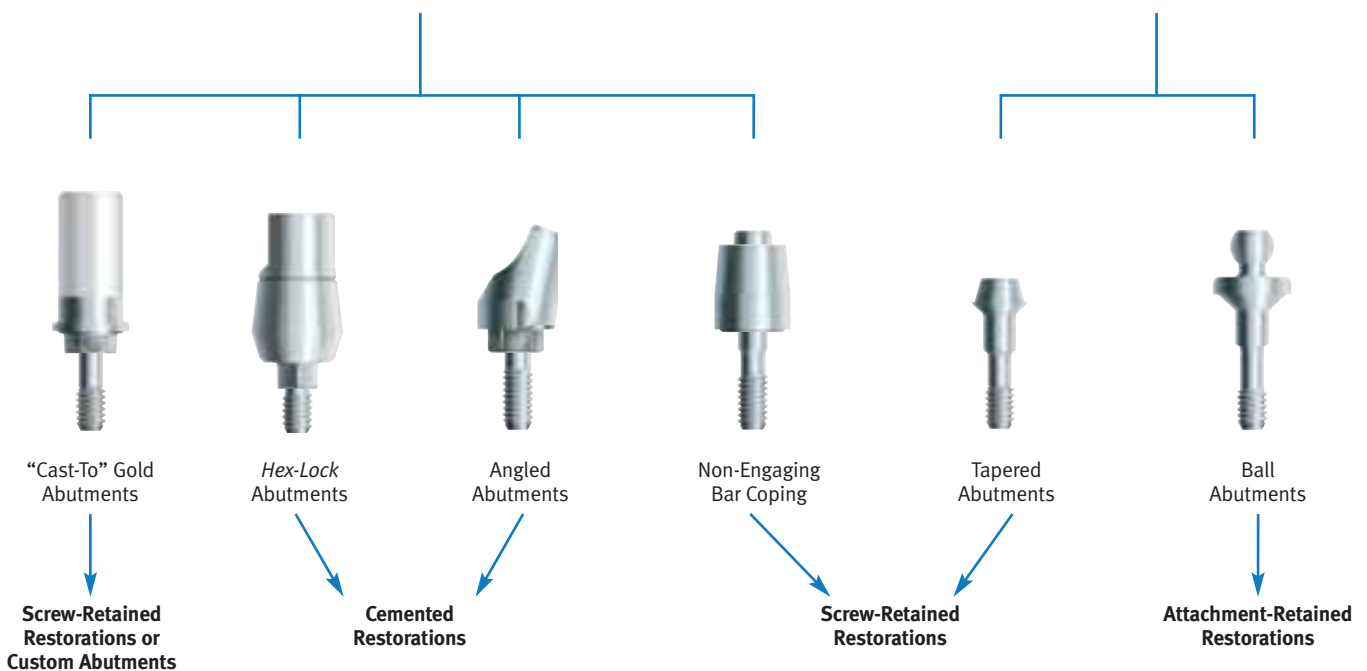
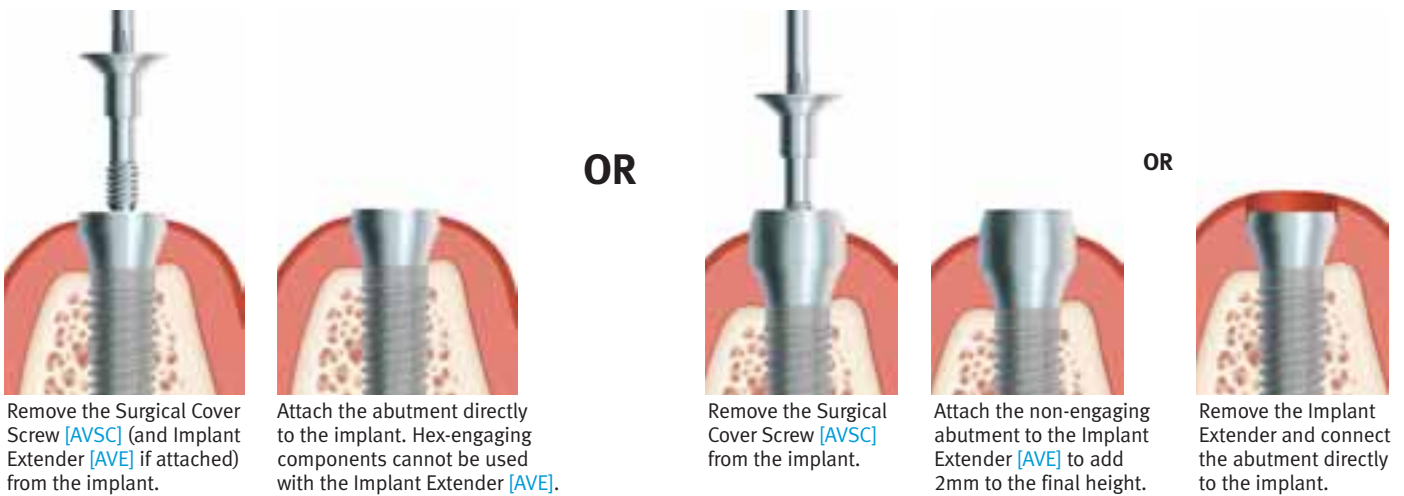













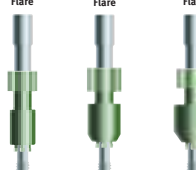
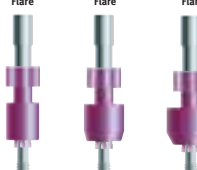

All non-engaging components consist of a one-piece base with an Abutment Screw [AVGC3 and AVGC5] or an abutment body and screw machined in one piece, commonly referred to as a One-Piece Abutment [AVACT, AVACT3 and AVBA]. These components do not engage the hex of the implant and can only be used for multiple-unit splinted restorations or attachment overdentures.

One-Stage, Non-Submerged Surgical Protocol



Zimmer Dental offers a full range of easy-to-use components to meet all your restorative needs. To use this guide, choose the column for the implant platform you wish to restore. You can follow the column down each page to identify the appropriate healing collars, transfer components and abutments for the type of restoration you are restoring: cement-retained, screw-retained or overdenture. Provisional abutments are also available.

- *Tapered Screw-Vent* Implants are offered with three color-coded prosthetic platforms: 3.5mmD, 4.5mmD & 5.7mmD.
- *AdVent* Implants feature a 4.5mmD platform that is different from the *Tapered Screw-Vent* 4.5mmD platform, and a 5.7mmD platform that utilizes *Tapered Screw-Vent* 5.7mm prosthetics.
- *Tapered Screw-Vent* (and soon *AdVent*) Implants are packaged with a proprietary Fixture Mount/Transfer which functions as a fixture mount, an impression post and/or a preparable temporary abutment. These parts can also be purchased individually.

	Tissue Healing			
	3.5mmD Platform	4.5mmD Platform	5.7mmD Platform*	AdVent 4.5mmD Platform
Healing Collar (3mm length pictured. Part #'s for 3mmL, 5mmL & 7mmL are listed)	 THC3/3 THC3/4 THC3/5 THC5/3 THC5/4 THC5/5 THC7/4	 THCW3/4 THCW3/5 THCW3/6 THCW5/4 THCW5/5 THCW5/6 THCW7/4	 TH5C3/6 TH5C5/6	 AVE (Implant Extender)
	Impression Transfer			
	3.5mmD Platform	4.5mmD Platform	5.7mmD Platform*	AdVent 4.5mmD Platform
Indirect Transfer (w/ screw for Closed Tray Impressions)	 HLT3/3 HLT3/4 HLT3/5	 HLT4/4 HLT4/5 HLT4/6	 HLT5/6	 AVIT/4
Direct Transfer (w/ screw for Open Tray Impressions)	 DHT3/3 DHT3/4 DHT3/5	 DHT4/4 DHT4/5 DHT4/6		 AVIT/4 DHTS
Implant Analog	 IA3	 IA4	 IA5	 AVR
	Provisional Restorations			
	3.5mmD Platform	4.5mmD Platform	5.7mmD Platform*	AdVent 4.5mmD Platform
Plastic Temporary Abutment (w/ screw) can be used for Cement- or Screw-Retained Restorations	 HLPT3	 HLPT4	 HLPT5	
Fixture Mount/ Transfer (w/ screw)	 FMT3	 FMT4	 FMT5	 FMA4

Note: AdVent Implant 5.7mmD platform uses FMA5.

*Note: 5.7mmD platform components are compatible with AdVent 5.7mmD platform.

Cement-Retained Restorations, Straight

	3.5mmD Platform	4.5mmD Platform	5.7mmD Platform*	AdVent 4.5mmD Platform
Zimmer Contour Ceramic Abutment** (w/ screw)	4.5mm flare ZRA341S ZRA342S	5.5mm flare ZRA451S ZRA452S		
Hex-Lock Contour Abutment (w/ screw) (Abutments for 4.5mmD x 4.5mm flare are listed but not pictured)	4.5mm flare ZOA341S ZOA342S ZOA343S	5.5mm flare ZOA451S ZOA441S ZOA452S ZOA442S ZOA453S ZOA443S	6.5mm flare ZOA561S ZOA562S ZOA563S	
Note: Impression caps, analogs, provisional copings and waxing copings sold separately by flare diameter. Call for availability.				
Hex-Lock Abutment (w/ screw)	3.5mm Flare HLA3/3	4.5mm Flare HLA3/4	5.5mm Flare HLA3/5	4.5mm Flare HLA4/4
		4.5mm Flare HLA4/5	5.5mm Flare HLA4/6	6.5mm Flare HLA5/6
				4.5mm Flare AVHL/4
				6.5mm Flare AVHL/6

Cement-Retained Restorations, Angled

	3.5mmD Platform	4.5mmD Platform	5.7mmD Platform*	AdVent 4.5mmD Platform
Hex-Lock Contour Abutment, 17° (w/ screw) (Abutments for 4.5mmD x 4.5mm flare are listed but not pictured)	4.5mm flare ZOA341A ZOA342A	5.5mm flare ZOA451A ZOA441A ZOA452A ZOA442A	6.5mm flare ZOA561A ZOA562A	
Note: Impression caps, analogs, provisional copings and waxing copings sold separately by flare diameter. Call for availability.				
20° Angled Abutment for 6 and 24 positions (w/ screw)	 AH20/4 AH20	 AH20W/5 AH20W	 A5H20/6 A5H20	 AVH20/4

Custom Restorations

	3.5mmD Platform	4.5mmD Platform	5.7mmD Platform*	AdVent 4.5mmD Platform
"Cast-To" Gold Abutment w/ screw				
Single-Unit Restorations (Engaging)	 HLA3G	 HLA4G	 HLA5G	 AVGA
Multi-Unit Restorations (Non-Engaging)	 NEA3G	 NEA4G		 AVGC3 Bar Gold Coping w/ Screw

*Note: 5.7mmD platform components are compatible with AdVent 5.7mmD platform.

**Call for availability.

Screw-Retained Restorations



Note: Use AVE for additional 2mm of collar height when using Tapered Abutments on AdVent Implants. TAC5 and TACW5 also available.

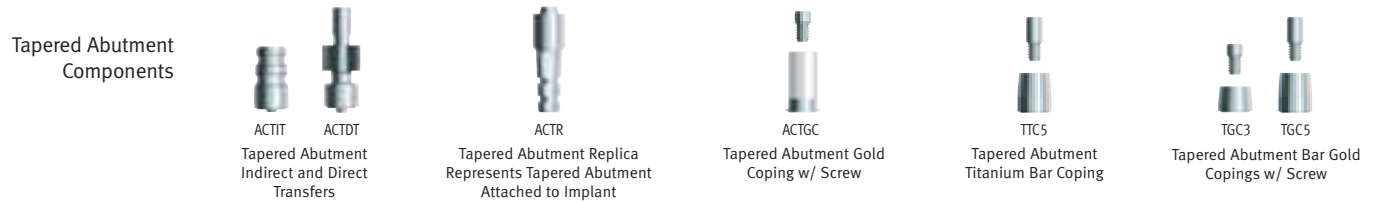

Overdenture Restorations



Note: Additional cuff options are available. See product catalog for complete list.



Note: Additional Locator Bar Components and Replacement Males are available. See product catalog.

Overdenture Restorations

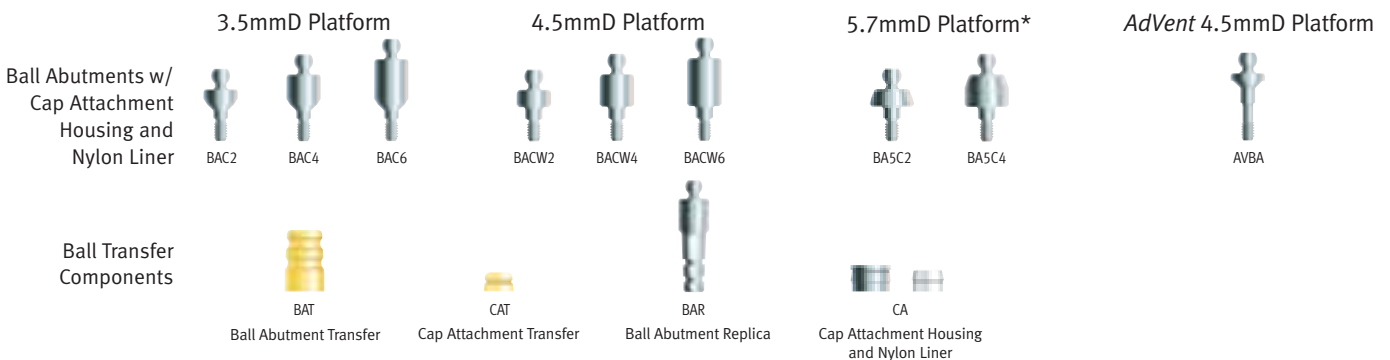

Note: BAT and BAR not for use with the 5.7mmD platform abutment. Use AVE for additional 2mm of collar height when using Ball Abutments on AdVent Implants.

Color-Coding for Internal Hex Platform

The chart below indicates which color corresponds to each *Tapered Screw-Vent* and *Screw-Vent* internal hex platform diameter.

- ◆ **Green** 3.5mm Implant Platform
- ◆ **Purple** 4.5mm Implant Platform
- ◆ **Yellow** 5.7mm Implant Platform

*Note: TSV 4.5mmD platform components are not interchangeable with AdVent 4.5mmD platform. 5.7mmD platform components can be used with TSV or AdVent Implants.



Restorative Manual



Impression Transfer System

Implant-level Indirect Transfers for closed-tray, transfer impression technique

Designed to transfer the soft tissue profile as well as the implant's position and hex orientation, Indirect Transfers remain attached to the implants when the closed-tray impression is removed from the mouth. The transfer is then retrieved from the implant, mated to the corresponding Implant Analog, and placed into its corresponding impression hole. To fabricate a working cast containing a replica of the implant in the patient's mouth, the impression is poured in dental stone. In areas where a longer transfer is required, the transfer's screw can be replaced by the Transfer Extension Screw [HLTE for internal hex implants], which adds an additional 3mm to the overall length of the transfer.



Exposing the tops of the implants

Tapered Screw-Vent and Screw-Vent Implants:

- Remove the Healing Collars with the 1.25mmD Hex Tool.

AdVent Implants:

- Remove the Surgical Cover Screws [AVSC] with the Hex Tool and Implant Extender [AVE] if present.



Attaching the transfers

Indirect Transfers are available in various profile diameters to replicate anatomical tissue sulcus in the working cast. Orient the flat side of the Indirect Transfer [HLT Series or AVIT/4] or Fixture Mount/Transfer toward the buccal surface, interdigitate its hex with the implant's hex and press the transfer onto the implant. Thread the transfer screw into the implant and finger-tighten with the 1.25mmD Hex Tool.



Making the transfer impression

Take a radiograph or use a non-abrading explorer to verify that the Indirect Transfers are fully seated. Block out the hex holes in the tops of the transfer screws with medium of choice to prevent the ingress of impression material. Remove excess material so that the block-out is flush with the ends of the transfer screws. Failure to do so may prevent an accurate transfer procedure.

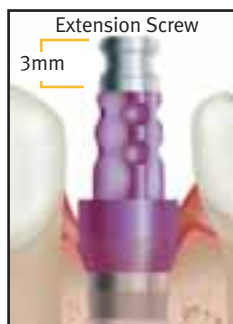

Verifying the fit of the impression tray

Verify that the Indirect Transfers fit within the confines of the custom tray or the modified stock tray prior to injecting the impression material.

In areas where a greater length of transfer body is required, replace the transfer screw with the Extension Screw [HLTE] for two-stage internal hex implants. This will increase the length of the transfer by 3mm and provide another circumferential groove for added vertical retention.



Injecting the impression material

An elastomeric impression material is recommended, such as vinyl polysiloxane. Inject light-body impression material around the transfers and fill the closed tray with heavier-body impression material. Make a full-arch impression, and allow the material to set according to the manufacturer's recommendations before removing. Unthread the Indirect Transfers from the implants in the patient's mouth. Make interocclusal records and an impression of the opposing arch. Send the impressions and transfer assemblies to the laboratory for fabrication of the working casts. Replace the Healing Collars on the implants in the patient's mouth.

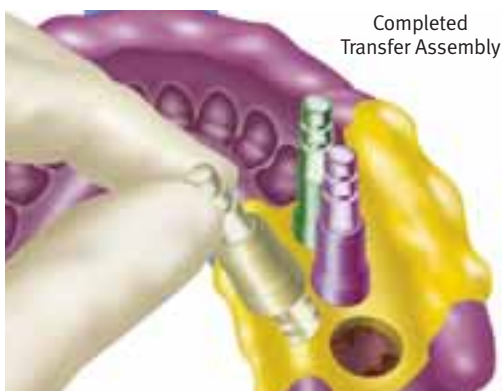

Seating the transfer assembly

Attach the Indirect Transfers to corresponding Implant Analogs with the Hex Tool:

- Implant Analog for an internal hex implant, 3.5mmD platform: **IA3**.
- Implant Analog for an internal hex implant, 4.5mmD platform: **IA4**.
- Implant Analog for an internal hex implant, 5.7mmD platform: **IA5**.
- Implant Analog for an *AdVent* Implant with 4.5mmD platform: **AVR**.
- Implant Analog for an *AdVent* Implant with 5.7mmD platform: **IA5**.

Align the flat side of each transfer with the flat side of its corresponding hole in the impression and insert the transfer assembly into the impression material. A double-click will indicate when the assembly has fully seated.

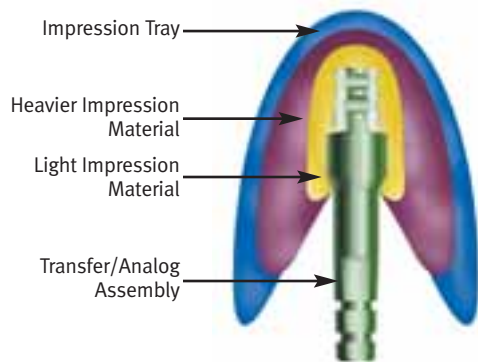

Cross-section of transfer impression

From the cross-section of the Indirect Transfer impression, note that there is no access to the transfers from outside of the impression tray.



Fabricating the working cast

Place soft tissue replication material around the junctions of the assembled Implant Analogs and the transfers inside the impression. Take care not to cover the retention grooves of the Implant Analogs with the material. After the material sets, pour the impression in dental stone.



Fabricating the working cast

After the dental stone sets separate the cast from the impression. The Implant Analogs will be incorporated within the stone cast with the same hex positions and orientations as the implants in the patient's mouth. Unthread and remove the transfers from the Implant Analogs with the Hex Tool. The soft tissue replication material can be removed for a visual inspection of the abutment/Implant Analog connections, if desired.

Pour the opposing-arch impression in dental stone, then utilize the interocclusal records to articulate the casts.

Implant-level Direct Transfers for open-tray, pick-up impression technique

Designed to transfer the soft tissue profile as well as the implant's position and hex orientation, Direct Transfers are held firmly within the open-tray impression as it is removed from the mouth. Therefore, the central transfer screw must be removed before the impression can be released from the mouth. This transfer procedure requires a custom tray or modified stock tray with screw access holes in the areas occlusal to the implants. The Implant Analog is connected to the Transfer embedded within the impression, then the impression is poured in dental stone to fabricate a working cast containing a replica of the implant in the patient's mouth.

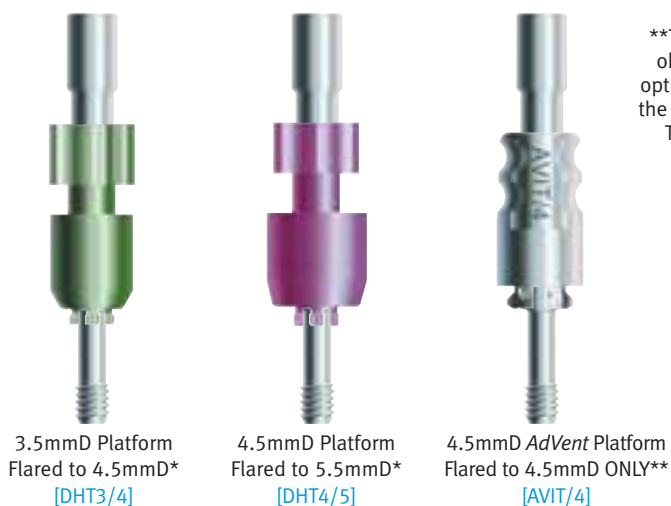

**This assembly is obtained with an optional purchase of the [DHTS] Open-Tray Transfer Screw.

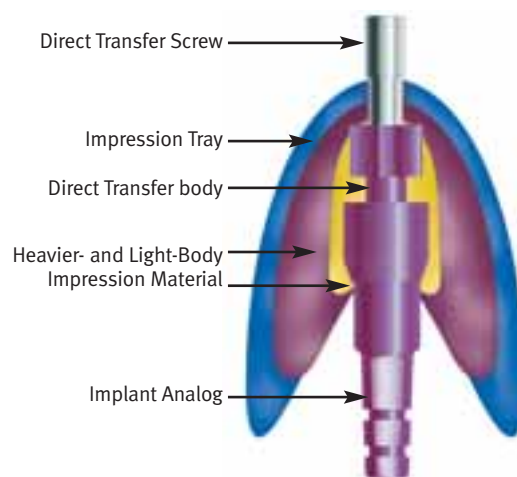

*Available in all three profile diameters.



Fabricating a custom tray

Make a full-arch impression of the Healing Collars or Surgical Cover Screws, edentulous areas and remaining dentition. Send it to the laboratory for fabrication of a preliminary cast and custom impression tray. Alternatively, select a stock tray and mold the border with greenstick compound material. The patient's existing, modified prosthesis can continue to be worn during the laboratory phase.

Fabricating a custom tray

Pour the impression in dental stone and separate the preliminary cast after it sets. Block out the areas above the Healing Collars or Surgical Cover Screws with baseplate wax to simulate the positions of the implant transfers that will be used.

Fabricate the custom impression tray with autopolymerizing or light-cure tray resin. Create an opening above the implant areas to allow for access to the Direct Transfer screws.





Removing the healing components

Expose the tops of the implants:

Tapered Screw-Vent and Screw-Vent Implants:

- Remove the Healing Collars or Surgical Cover Screws with the 1.25mmD Hex Tool.

AdVent Implants:

- Remove the Surgical Cover Screws with the 1.25mmD Hex Tool. Remove the *AdVent Extender [AVE]*, if present, prior to impression making.

Select the transfers according to the implant platform and the required profile diameters. Place a Direct Transfer onto each implant in the patient's mouth by interdigitating its hex with the hex of the implant.



Attaching the Direct Transfers

Use the 1.25mmD Hex Tool to thread the transfer screws through the transfer bodies and into the implants, then finger-tighten. In areas of limited vertical height, the transfer screws can be removed and shortened by 4mm with a cutting disc prior to use.

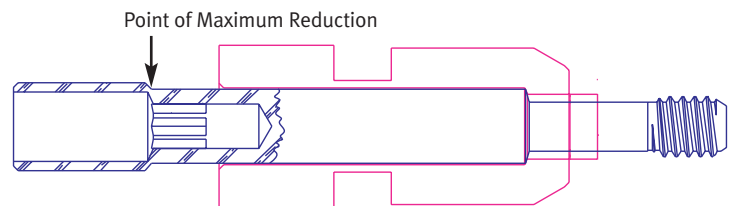

Verifying screw access through the top of the tray

Place the open-access tray over the assembled Direct Transfers in the patient's mouth to verify that the screws penetrate through the top of the tray without hindrance. Remove the open-access tray.



Making the transfer impression

An elastomeric impression material is recommended, such as vinyl polysiloxane. Inject light-body impression material around the Direct Transfers and fill the open-access tray with heavier-body impression material. Place the loaded tray into the patient's mouth and allow the screws to penetrate through the access area in the impression tray. Remove excess impression material from the tops of the screws and allow the impression material to set according to the manufacturer's recommendations. Unthread the screws from the transfers with the Hex Tool and remove them from the patient's mouth. Remove the tray from the mouth. The Direct Transfer bodies will be picked up and retained in the impression material.

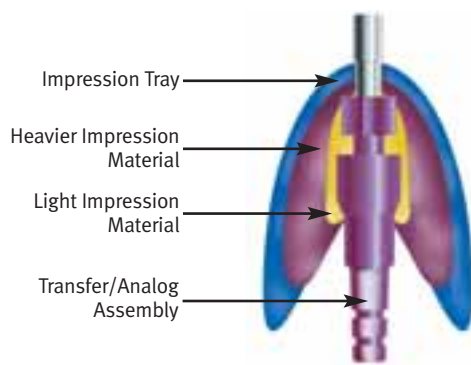

Completing the transfer procedure

Replace the healing components on the implants in the patient's mouth. Fabricate an opposing-arch impression and make interocclusal records. Send the impressions with included transfers to the laboratory for fabrication of the working casts. Stabilize each Implant Analog [IA3, IA4, IA5 and AVR] with forceps to prevent rotation, and insert the screw-receiving end of a corresponding Implant Analog into the base of the transfer body within the impression material.

Attach the transfer screw to the 1.25mmD Hex Tool, and insert it through the respective access hole in the back of the transfer tray. Pass the screw through the embedded transfer body and thread it into the attached Implant Analog to lock the components together.

Cross-section of transfer impression

From the cross-section of the Direct Transfer impression, note that there is access to the transfer screw from outside of the impression tray.

Fabricating the working cast

Place soft tissue replication material around the junctions of the assembled Implant Analogs and the transfers inside the impression. Take care not to cover the retention grooves of the Implant Analogs with the material. After the material sets, pour the impression in dental stone.

Fabricating the working cast

Use the 1.25mmD Hex Tool to unthread and remove the transfer screws after the dental stone sets. Separate the cast from the impression (the open-tray transfer bodies will remain in the impression). The Implant Analogs will be incorporated within the stone cast with the same hex positions and orientations as the implants in the patient's mouth. The soft tissue replication material can be removed for a visual inspection of the abutment/implant analog connections, if desired.

Pour the opposing-arch impression in dental stone, then utilize the interocclusal records to articulate the casts.



Option 1: making an implant-level impression

After threaded implant placement, block out the top of the Fixture Mount/Transfer. If implant does not have a transfer, attach transfer of choice with 1.25mmD Hex Tool. Place light-body impression material around the transfer and record a full-arch impression with standard body material.

Remove the impression after it fully sets. Remove transfer and forward with impression to the laboratory. If impression is done at the bone level, inform the laboratory. Optional: Long Impression Screw [DHTS] may be used for open-tray impression technique.



Option 2: using the surgical guide for indexing

After threaded implant placement, use a Long (Open-Tray) Impression Screw [DHTS] to project through surgical guide. Lute the Fixture Mount/Transfer or transfer post to the surgical guide with resin of choice. Unscrew the transfer and remove the guide with transfer attached. Forward guide and transfer to the laboratory for retrofitting of the operative model.

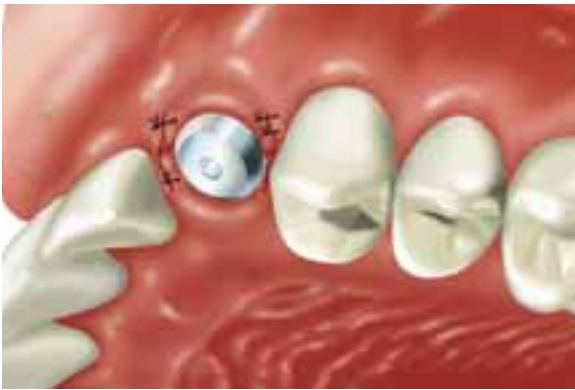

Attaching components for healing period

- 1) Place Surgical Cover Screw using 1.25mmD Hex Tool and then suture for traditional two-stage protocol.
- 2) Attach a Healing Collar with the corresponding profile and platform diameter for single-stage protocol.

Forward the impression, transfer and diagnostic models to the laboratory for fabrication of the working cast.



Fabricating the working cast

Place soft tissue replication material around the junctions of the assembled Implant Analog and the transfer inside the impression. After the material sets, pour the impression in dental stone. Separate the cast from the impression. The Implant Analog will be incorporated within the stone cast with the same hex positions and orientations as the implant in the patient's mouth. Unthread and remove the transfer from the Implant Analog with the 1.25mmD Hex Tool. The soft tissue replication material can be removed for a visual inspection of the abutment/Implant Analog connections, if desired.

Pour the opposing-arch impression in dental stone, then utilize the interocclusal records to articulate the casts.



Restorative Manual



Hex-Lock Plastic Temporary Abutments

Restorative options with Hex-Lock Plastic Temporary Abutments

The *Hex-Lock* Plastic Temporary Abutment consists of a plastic cylinder with retentive parallel walls. The flared cuff of the Temporary Abutment helps create a natural emergence profile during tissue healing. The Temporary Abutment may be used for cement- or screw-retained crowns and in a laboratory or chairside procedure. The abutment's long retaining screw is useful for maintaining the screw access channel in a screw-retained prosthesis or is easily prepared to allow for a cement-retained restoration. The *Hex-Lock* Plastic Temporary Abutment is indicated for short-term restorations (28 days or less) and is not to be used in interocclusal spaces less than 4mm or to correct divergence of more than 25°. The temporary abutment is contraindicated for use as a final abutment.



Figure 1 - Hex-Lock Plastic Temporary Abutment and Retaining Screw

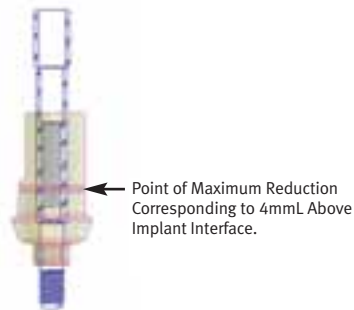
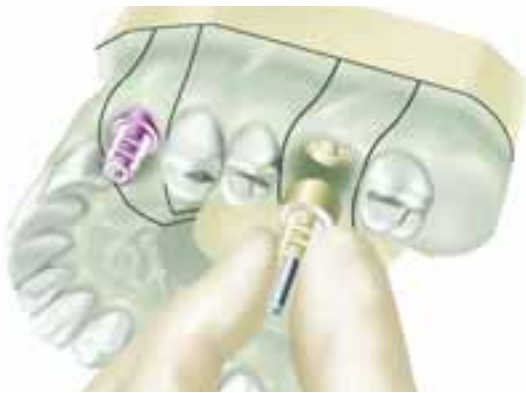

Figure 2 - The Hex-Lock Temporary Abutment should not be reduced to less than 4mm in height. A groove on the abutment's cylinder indicates 4mm.



Fabricating the articulated casts

Pour the working cast in dental stone. Use soft tissue material to represent gingival contours if desired. Remove transfers from cast. Pour the opposing arch impression in dental stone and utilize interocclusal bite registration to articulate the casts.



Creating a diagnostic wax-up

Create a diagnostic wax-up of the teeth to be replaced using traditional prosthodontic techniques with proper tooth morphology. Duplicate the diagnostic wax-up by recording an alginate impression, and pour a plaster cast. Use a vacuform machine to create the plastic matrix.



Preparing the plastic shell form

Remove the plastic matrix and form the duplicated cast. Trim and re-seat the clear matrix and check fit. Drill a small hole in the occlusal aspect of the matrix and reseat it over the Temporary Abutment, allowing the abutment screw of the Plastic Temporary Abutment to protrude through.

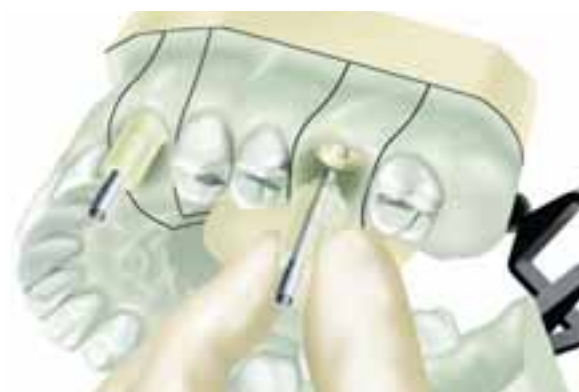

Attaching the abutments to the working cast

Attach the corresponding Plastic Temporary Abutments to the Implant Analogs or to the implants in a chairside procedure. Use a 1.25mmD Hex Tool to tighten the abutment screw, using finger-pressure only.

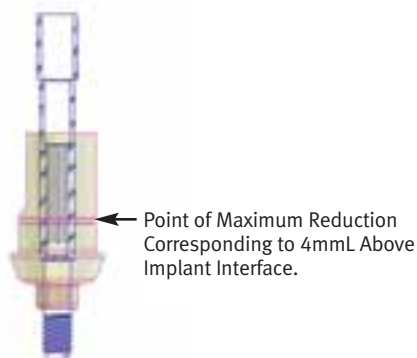

Preparing the Temporary Abutment

Mark the required modifications on the abutment to allow for the appropriate occlusal clearance, gingival contouring and prosthesis design for adequate thickness of veneering material. Note: When fabricating multiple-unit screw-retained restorations, one or all of the abutment's hex connection may need to be removed to avoid interference of the multiple hexes when seating the restoration.



Modifying the abutment

Screw-retained (molar shown): Reduce the abutment height as necessary, leaving the abutment screw long to protrude through the vacuform. Roughen the entire abutment surface to enhance retention of the acrylic.

Cement-retained (canine shown): Reduce and prepare the abutment and screw as needed. Roughen the abutment surface to enhance retention of the cemented restoration.



Preparing the cast for temporary material

Screw-retained (molar shown): Block out undercuts and apply separating medium to the cast, ensuring none is applied to the Temporary Abutments.

Cement-retained (canine shown): Cover the abutment with wax or petroleum jelly to prevent adherence of temporary material.

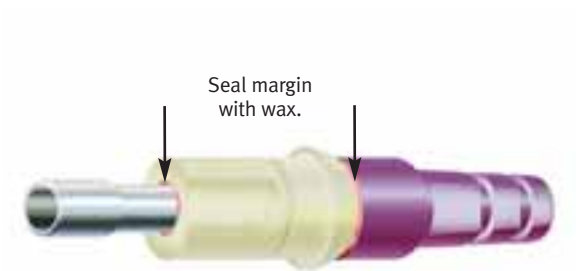

Sealing voids and margin

To avoid ingress of excess monomer in the indicated areas, seal the void around the screw as it enters the screw access channel. Seal the junction of the abutment to the analog in a similar fashion. **Do not apply monomer as a whetting agent directly to the abutment.**

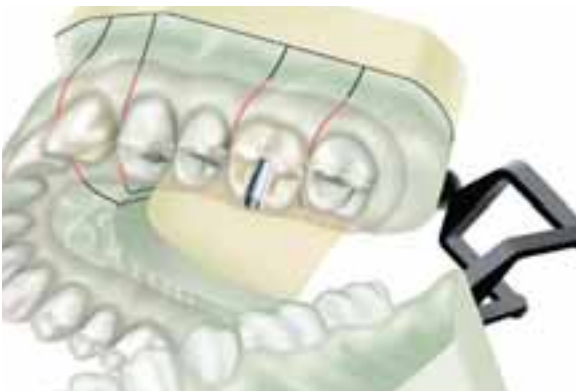

Fabricating the provisional prosthesis

Allow the screw to pass through the vacuform, fill the vacuform with temporary material and place over the trimmed abutments. Follow manufacturer's guidelines to cure temporary material.



Completing the provisional prosthesis

Follow standard laboratory procedures to complete both the cement- and screw-retained provisional prostheses. Trim the abutment screws to accommodate lingual, occlusal and incisal contours.



Delivering the provisional prosthesis

Screw-retained (molar shown): Attach the one-piece abutment/provisional to the implant and check the occlusion. Tighten the abutment screw, reduce the screw shaft by cutting with a fissure bur and block out the screw access hole.

Cement-retained (canine shown): Tighten the abutment screw and block out the screw access hole. Cement the provisional with temporary cement and check the occlusion.



The provisional prosthesis

Completed provisional restorations are in place. Note: The gingival contours of the temporary prosthesis may not match the flare of the temporary cuffs or the final prosthetic abutment. Additional treatment planning and or modifications to the Temporary Abutment may be needed to accommodate specific tissue contour. Note: Do not use a torque wrench to secure the Temporary Abutment to the implant body. Hand-tighten only.



Restorative Manual



Hex-Lock Contour Abutment System

Restorative options with Hex-Lock Contour Abutment System

Hex-Lock Contour Abutments are designed with predefined margins and varying cuff heights. The height of the cuff is higher on the lingual aspect by 1.5mm to mimic the soft tissue profile. The contoured design minimizes preparation time and reduces the potential for metal exposure due to tissue remodeling.

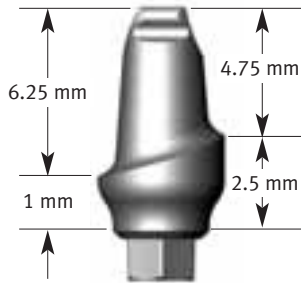

Figure 1 - Mesial/distal view.



Figure 2 - Contour Impression Cap on Abutment.



Figure 3 - Contour Provisional Coping, Abutment Analog and Waxing Coping.



Hex-Lock Contour Abutments can be used to support single- or multiple-unit cement-retained restorations. The cone of the abutment is 6.25mm in height above the buccal margin and 4.75mm above the lingual margin with an 8° taper (4° per side). The abutments are available in straight and 17° preangled versions in a variety of emergence profiles. Like original *Hex-Lock* Abutments, *Hex-Lock* Contour Abutments are made from titanium alloy and have a hex configuration with a one-degree taper to create a friction-fit connection to the implant.

A system of caps and copings fit over the *Hex-Lock* Contour Abutments to aid in making restorations using traditional prosthodontic techniques.

- Color-coded snap-on impression caps allow for simple abutment-level impressions.
- Provisional copings help in creating a provisional crown to shape gingival tissue while the final restoration is being fabricated.
- Analogs and waxing copings assist the laboratory in fabrication of the final restoration.
- All four restorative components are sold together as a Contour Restorative Kit or may be purchased individually.
- Abutment Try-ins can be used in the laboratory or in the clinician's office.
- Contour Healing Caps are available for long-term tissue healing.

The Contour Impression Cap snaps into a groove on the *Hex-Lock* Contour Abutment to facilitate easy impression-taking. The impression cap is picked up in the cured impression and is fit together with the Contour Abutment Analog for model creation. The impression caps are color-coded by flare diameter, and abutment analogs have the same corresponding color (see Color-Coding Chart below).

Color-Coding for Contour Impression Caps and Contour Abutment Analogs

Color	Emergence Profile Diameter
 Tan	4.5mm
 Rose	5.5mm
 Yellow	6.5mm



Exposing the top of the implant

Remove the Surgical Cover Screw or Healing Collar from the implant using a 1.25mmD (0.050") Hex Tool.



Selecting and seating Hex-Lock Contour Abutment

Hex-Lock Contour Abutments consist of an abutment body with prepared margins and an abutment screw. Contour abutments are available in straight and 17° angled versions in a variety of cuff heights and emergence profiles for various tooth locations. To seat the abutment, interdigitate the abutment's hex with the hex of the implant, orienting the short side of the cuff to the buccal aspect. Tighten the abutment screw to 30 Ncm with a calibrated prosthetic torque wrench to ensure a friction-fit connection with the implant is obtained. Verify with an x-ray that the abutment is fully seated.

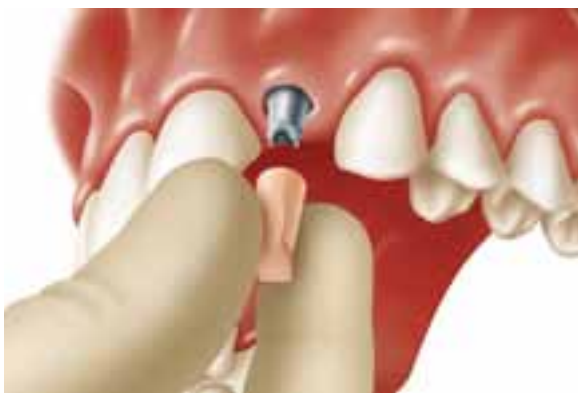

Making the abutment-level impression

Place the impression cap over the abutment, making sure the cap is aligned with the contours of the margin. The long flat on the buccal aspect of the impression cap may be used as a reference for positioning the cap properly. Snap cap into place. Please Note: If modifications to the Contour Abutment are necessary, do not use the Contour Impression Cap. A direct technique (traditional crown and bridge impression), ensuring complete exposure of the modified margin, or an indirect impression utilizing an implant-level impression post and analog must be used if the abutment margins have been adjusted.



Completing the impression procedure

An elastomeric impression material, such as vinyl polysiloxane or polyether should be used. A light-bodied material may be injected around the impression cap as in the utilization of a "wash" technique. Fill the tray with medium- to heavy-bodied impression material in preparation for a full-arch impression. Place the loaded tray into the patient's mouth and allow the impression material to set according to the manufacturer's recommendations. Remove the tray from the mouth. The Contour Impression Cap will be retained in the impression material. Take an impression of the opposing arch and record bite.



Fabricating and cementing the provisional prosthesis

Prepare the provisional crown by applying acrylic to the Contour Provisional Coping according to traditional prosthodontic techniques. Block out the screw access hole and cement the provisional prosthesis onto the *Hex-Lock* Contour Abutment with soft-access cement. Alternatively, use the provisional coping as a base for the fitting of a pre-fabricated shell crown as the temporary restoration.



Attaching the Contour Abutment Analog

Align the Contour Abutment Analog with the corresponding color-coded Contour Impression Cap in the impression and snap the analog into place. The abutment analog will replicate the *Hex-Lock* Contour Abutment in the stone model.



Pouring the working cast

Using soft tissue material to represent gingival contours, pour the model in die stone. Utilize interocclusal bite registration to articulate the working cast with the opposing model.



Utilizing the Contour Waxing Coping

Place the Contour Waxing Coping on the abutment analog in the model, aligning the coping with the contours of the margin. Use wax, resin or other waxing materials to seal the margin area.

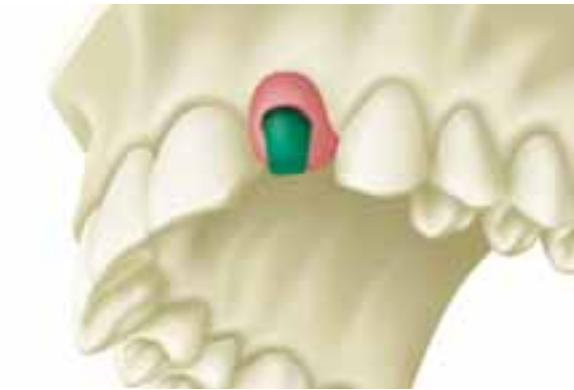

Fabricating the wax coping

Create the wax coping according to traditional crown and bridge procedures. Attach a 10-gauge sprue with reservoir to the thickest part of the wax coping. Add an auxiliary sprue and vent as needed.

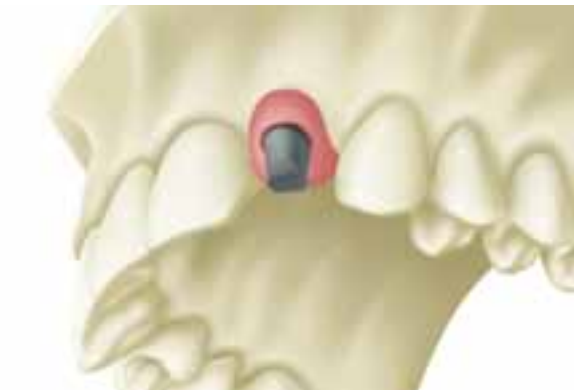

Casting the wax pattern

Follow traditional techniques to cast and finish the wax-up coping or metal frame. Send it to the clinician for a patient try-in. The dentist should confirm fit and marginal integrity before the veneering material is applied.



Finishing the final prosthesis

Apply the veneering material to the metal coping according to routine laboratory procedures. Send the finished restoration to the clinician for final delivery.



Delivering the final prosthesis

Remove the provisional restoration and any remaining cement from the abutment. Retorque the abutment to 30 Ncm with a calibrated torque wrench. Seal the screw access channel in the abutment with a cotton pellet, light-curing resilient material or gutta-percha. This will ensure future access to the screw head. Seat the final prosthesis onto the abutments and confirm fit, contour and marginal integrity. Check the bite for function and occlusion. Cement the final prosthesis with a cement of choice. To facilitate future retrievability, a soft-access or temporary cement may be used. Provide the patient with oral hygiene instructions prior to release.



Restorative Manual



Hex-Lock Abutment System

Hex-Lock Abutments are manufactured from titanium alloy and used as the support foundation for single- or multiple-unit cement-retained, partially edentulous fixed restorations. These abutments consist of an abutment (fixation) screw and a preparable base which consists of a profiled upper portion, and an apex with a hex configuration with one-degree tapered flats, enabling it to friction-fit to the hex of the implant. The abutment base can be modified either chairside or in the laboratory, to create a variety of contoured margins and abutment profiles to emulate the contours of the natural teeth it is replacing. Once prepared, these abutments are attached to the implant and impressed following conventional crown and bridge techniques.

Cemented Crown



Cemented Fixed Partial Denture



Cemented Fixed Partial Denture



**Abutment for
the Internal Hex
Implant, 3.5mmD
platform**



Hex-Lock Abutment
[HLA3/4]



**Abutment for
the Internal Hex
Implant, 5.7mmD
platform**



Hex-Lock
Abutment
[HLA5/6]



**Abutment for
the Internal Hex
Implant, 4.5mmD
platform**



Hex-Lock
Abutment
[HLA4/5]



**Abutment for the
AdVent Implant,
4.5mmD platform**



Hex-Lock
Abutment
[AVHL/4]



**Abutment for the
Wide Platform
AdVent, 5.7mmD
platform**



Hex-Lock
Abutment
[HLA5/6]





Selecting the Hex-Lock Abutments

Fabricate the working cast utilizing one of the transfer procedures mentioned in the previous section. *Hex-Lock* Abutments (“abutment”) consist of an abutment body and an abutment screw. Abutments and corresponding transfers are available in a variety of diameters and flares designated for specific tooth locations. Note: The abutment should have the same profile as the Healing Collar and Direct or Indirect Transfer. For the *AdVent* Implant with the 4.5mmD platform, the Indirect Transfer [AVIT/4] is used for both the 4.5mmD and 6.5mmD *Hex-Lock* Abutments. The *AdVent* Implant with the 5.7mmD platform uses the Indirect Transfer [HLT5/6], matching the 5.7mmD platform of the *Tapered Screw-Vent* product line.



Seating the Hex-Lock Abutments

Interdigitate the abutment’s hex with the hex of the Implant Analog in the working cast (or implant in the patient’s mouth) and place the abutment onto the Implant Analog (or implant). Thread the abutment screw through the abutment body and into the Implant Analog (or implant) with the Hex Tool. To complete seating and create a friction-fit connection, tighten the abutment screw to 30 Ncm with a calibrated torque wrench.

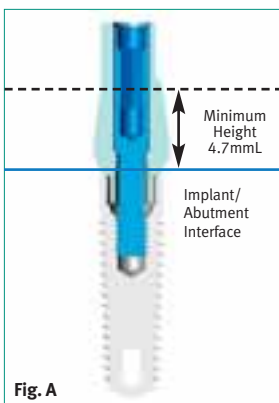

Fig. A
Hex-Lock Abutment with optional Abutment Screw [HLTS2].

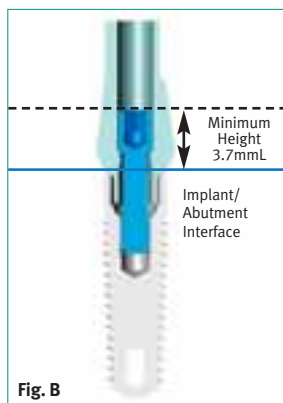

Fig. B
Hex-Lock Abutment with standard Abutment Screw [MHLAS].

Determining Hex-Lock Abutment modifications

Hex-Lock Abutments extend 8.7mm vertically above the implant/abutment interface. Visually determine the modifications necessary for establishing marginal and vertical contours. The abutments have one score line placed 4.7mm above the top of the implant. When using the [MHLAS] Screw (included with the abutment), the maximum preparation on the abutment is 1mm below this line (Fig. B). If using the taller [HLTS2] Screw (sold separately), do not prepare the abutment below the score line in order to preserve adequate hex engagement within the screw (Fig. A).

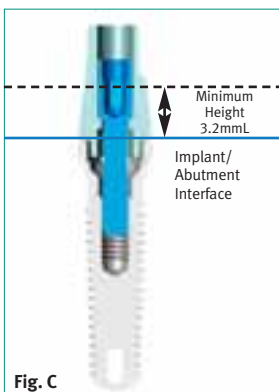
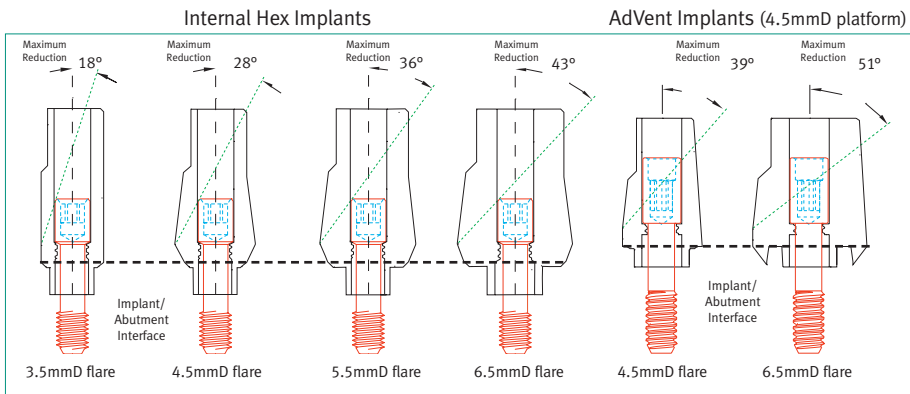

Fig. C
AdVent Hex-Lock Abutment with Abutment Screw [AVHLS].

Determining AdVent Hex-Lock Abutment modifications

Hex-Lock Abutments for the *AdVent* Implant extend 7.0mm vertically above the top of the implant/abutment interface. Visually determine the modifications necessary for establishing marginal and vertical contours. To preserve sufficient hex engagement within the abutment screw, do not vertically reduce the abutment below the score line. This reduction will produce an abutment 3.2mm in height above the top of the Implant Analog (or implant).



Preparing abutments to maximum angle

Hex-Lock Abutments can be prepared at an angle to achieve mutual parallelism and to create a favorable path of draw for the prosthesis. When these components are used with the standard Abutment Screws [MHLAS], the maximum angles of correction shown on the left can be achieved.



Marking the abutment for desired preparation

Mark the required modifications to achieve appropriate vertical clearance as well as gingival contours. Note: The reduction of the abutment needs to take into consideration the following:

- 1) Type of restoration (for example, a ceramic or metal margin).
- 2) Desired thickness of alloy.
- 3) Desired thickness of veneering material.
- 4) Occlusal considerations: centric occlusion, protrusive or lateral excursion.

Use the Hex Tool to loosen and remove the abutment screw. Thread the Removal Tool [TLRT2] through the access channel in the abutment and rotate in a clockwise direction. Continued rotation of the tool will result in the abutment lifting off the implant.



Modifying the Hex-Lock Abutments

Attach the abutment to an additional Implant Analog located within the Abutment Holder [ABTH]. Modify the abutment with cut-off disks, heatless stone wheels and 12-fluted carbide burs. Use a diamond bur to define the margins. Create a dimple on the buccal surface to help orient the abutment on the implant. Preserve or redefine a flat surface as an anti-rotational feature. If modifying the abutments chairside, **proceed to placing the prepared abutments.**



Fabricating the provisional prosthesis

Replace the abutments on the working cast and make final adjustments. Take care not to damage the soft tissue material, which can be removed from the working cast, if necessary. If a diagnostic wax-up was made, make an alginate impression over it and pour the impression in dental stone. Mold a clear acrylic sheet onto the cast of the diagnostic wax-up according to the manufacturer's instructions. Remove the mold from the cast. Occlude screw access holes and lubricate the abutments and working cast and then flow temporary material into the areas of the abutments and missing teeth in the mold. Seat the mold onto the cast containing the prepared abutments. Trim the resulting provisional prosthesis and return it with the prepared abutments to the dentist.



Placing the prepared abutments

Sterilize the prepared abutments before replacing them into the patient's mouth. Interdigitate the hexes of each abutment and implant utilizing the dimple to orient the abutment in the correct spatial position. Thread the abutment screw through the abutment body and into the implant with the Hex Tool. Tighten each abutment screw to 30 Ncm with a calibrated torque wrench.



Making final adjustments to the abutments

With a round-end, 12-fluted carbide bur in a high-speed handpiece, make minor modifications to the gingival and vertical contours of the abutments under copious irrigation. After completing final modifications, retighten the abutment screws to the recommended torque. Take a radiograph to confirm that the abutments are fully seated.



Making an impression of the prepared abutments

Block out the hex holes in the tops of the abutment screws with a medium of choice to prevent the ingress of impression material. Remove excess material so that the block-out is flush with the ends of the abutment screws. Make a conventional, full-arch, crown and bridge impression with an elastomeric impression material, such as vinyl polysiloxane. To insure a proper fit of the finished restoration, the abutments must remain in the patient's mouth after completing the impression procedure. Send the impression to the laboratory to fabricate a porcelain-fused-to-metal bridge.



Cementing the provisional prosthesis

Block out the hex holes in the tops of the abutment screws with material of choice. If the laboratory has fabricated a provisional prosthesis, cement it onto the prepared abutments with soft-access cement. If a provisional prosthesis has not been fabricated, block out any undercuts and lightly lubricate the abutments. Fabricate a prosthesis over the abutments chairside with a light-cure or autopolymerizing tooth-colored acrylic material. For a more dense cure, remove the set provisional prosthesis from the mouth and place it in a curing unit. After curing, remove the restoration from the mold, trim and polish, then cement the finished provisional prosthesis onto the abutments.



Pouring the working cast

Pour the standard crown and bridge impression in die stone. An epoxy die material may be useful if preparations are extremely thin. Separate the cast from the impression. Follow standard laboratory procedures to produce a soft tissue model. Utilize the interocclusal records to articulate the working cast with the opposing-arch cast. Prepare the working cast to fabricate the wax framework pattern.

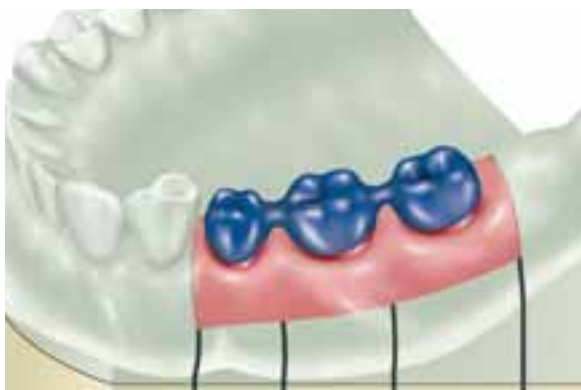

Fabricating the wax framework pattern

Create the wax framework pattern according to routine crown and bridge procedures.



Spruing, investing and casting the framework pattern

Attach 10-gauge sprue wax with reservoirs to the thickest part of each unit within the framework pattern. Add auxiliary sprues and vents to prevent porosity in the casting as needed.

Invest and cast the pattern in noble or high noble ceramic alloy according to the manufacturer's guidelines.



Finishing the cast framework

Divest the cast framework with ultrasonic cleaning and non-abrasive glass bead. Follow conventional laboratory techniques to fit and finish the cast framework. Seat the finished framework onto the working cast and confirm that a passive fit has been achieved. Place the framework on the working cast and send it to the clinician for a try-in of the metal framework. The dentist should confirm that a passive fit has been achieved before the veneering material is applied.



Trying in the finished framework

Remove the provisional restoration from the patient's mouth. Retorque the abutment screws to 30 Ncm with a calibrated torque wrench. Seat the finished framework onto the abutments. Verify that it fits passively, and that no additional finishing or adjustment is required. Remove the framework. Reseat the provisional prosthesis with soft-access cement.

Return the framework to the laboratory on the working cast for completion of the fixed partial denture.



Applying the porcelain (veneering material)

Prepare the framework to receive the opaque layer according to routine laboratory procedures.



Finishing the final prosthesis

Apply porcelain to the framework according to routine laboratory procedures.

Finish the porcelain and polish any metal margins, seat the finished prosthesis on the working cast and send it to the clinician for final delivery.



Delivering the final prosthesis

Remove the provisional restoration from the patient's mouth. Retorque the abutments to 30 Ncm with the calibrated torque wrench. Wait ten minutes, then retighten. This is done to compensate for clamping force lost due to screw embedment. Seal the screw access channel in each abutment with cotton pellets and light-curing resilient material or gutta-percha. This will ensure future access to the screw head. Seat the final prosthesis onto the abutments and confirm fit and contour. Check the occlusion. Verify that no additional finishing or adjustment is required. Cement the final prosthesis with a cement of choice. To facilitate future retrievability, a soft-access cement may be used. Provide the patient with oral hygiene instructions prior to release.



Restorative Manual



Angled Abutment System

Angled Abutments are used for cemented single- and multi-unit restorations when the long axis of the implant is approximately 15° to 30° out of parallelism with the clinical long axis of the adjacent teeth. There must be acceptable soft tissue thickness to establish margins at least 0.5mm subgingival for esthetics.

These abutment assemblies require minimum preparation, and consist of the following two options which are used accordingly, depending on the hex orientation of the implant.

- 1) When the hex of the implant is oriented at time of implant surgery, so that the flat surface of one side of the hexagon of the implant is toward the direction of the implant angulation, then use the two-piece Angled Abutment (Fig. 1). This design allows for 6 positional changes of 60°
- 2) When the hex of the implant is not oriented with one of its flats in the direction of the implant angulation, then use what is referred to as the three-piece Angled Abutment assembly. This assembly consists of a 20° angled head (Fig. 2) with a female octagon in the base that interdigitates with the male octagon of the abutment connector (Fig. 3). A vertical hole through the component provides access for the abutment screw (Fig. 4). This design allows for 24 positional changes of 15°

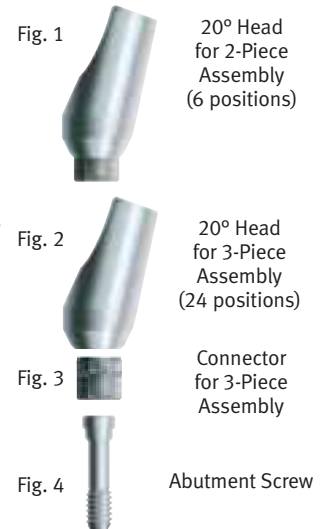

Three-piece abutment components:

Head: Angled at 20°, this portion of the abutment assembly functions as a support for the prosthesis, and can be prepared chairside or in the laboratory.

Connector: This intermediate component links the abutment head to the implant. It has a coronal octagon that interdigitates and forms a friction-fit with a mating octagon in the bottom of the abutment head, and a male hexagon at the base that interdigitates and forms a friction-fit connection with the implant's hex. By combining a mating hexagon with a mating octagon,

the abutment head can be oriented to 24 rotational positions for optimum placement. Inside the connector is a threaded bore that provides access for the abutment screw. When the abutment is fully assembled, the bottom of the abutment head interfaces directly with the top of the implant, and the connector strictly functions internally to link the two components together.



Common Abutment Screw: To form the friction-fit between the components, the abutment screw should be torqued to 30 Ncm. An internal hex in the top of the abutment screw accepts a 1.25mmD Hex Tool.



Restorative applications with the Angled Abutment

Cemented Crown



Cemented Fixed Partial Denture



Cemented Fixed Partial Denture



Angulation and transmucosal height requirements of the final abutment assembly

To allow for an esthetic, subgingival connection between the abutment and prosthesis interface, determine the appropriate tissue depth on the labial or buccal surface. The prosthesis type (i.e. whether the prosthesis will have a metal or porcelain margin) and the depth of the lingual sulcus must also be considered. Prior to selecting the abutment assembly, make a final assessment of the appropriate angulation and emergence profile requirements. Trim abutments to accommodate for variations in final shape and gingival contours of the restoration.

When fully seated, the bottom of the head component interfaces directly with the top of the implant.

After all the abutment components are in place, the minimum vertical clearance between the implant interface and the opposing dentition is 2.85mm for two-stage internal hex implants and 2.3mm for the one-stage *AdVent* Implants, as measured from top of the implant to the top of the abutment screw. These are maximum reduction heights although prosthodontic requirements for cement retention of prostheses might be higher.

Once seated, use the appropriate tools to disengage the friction-fit abutment connector from both the head component and the implant. Use the Removal Tool [TLRT2] to remove the assembled abutment or individual connector from the implant. Use the octagon-hexagon Removal Tool [OHRT] to remove the head component from the friction-fit connector if additional repositioning is required.

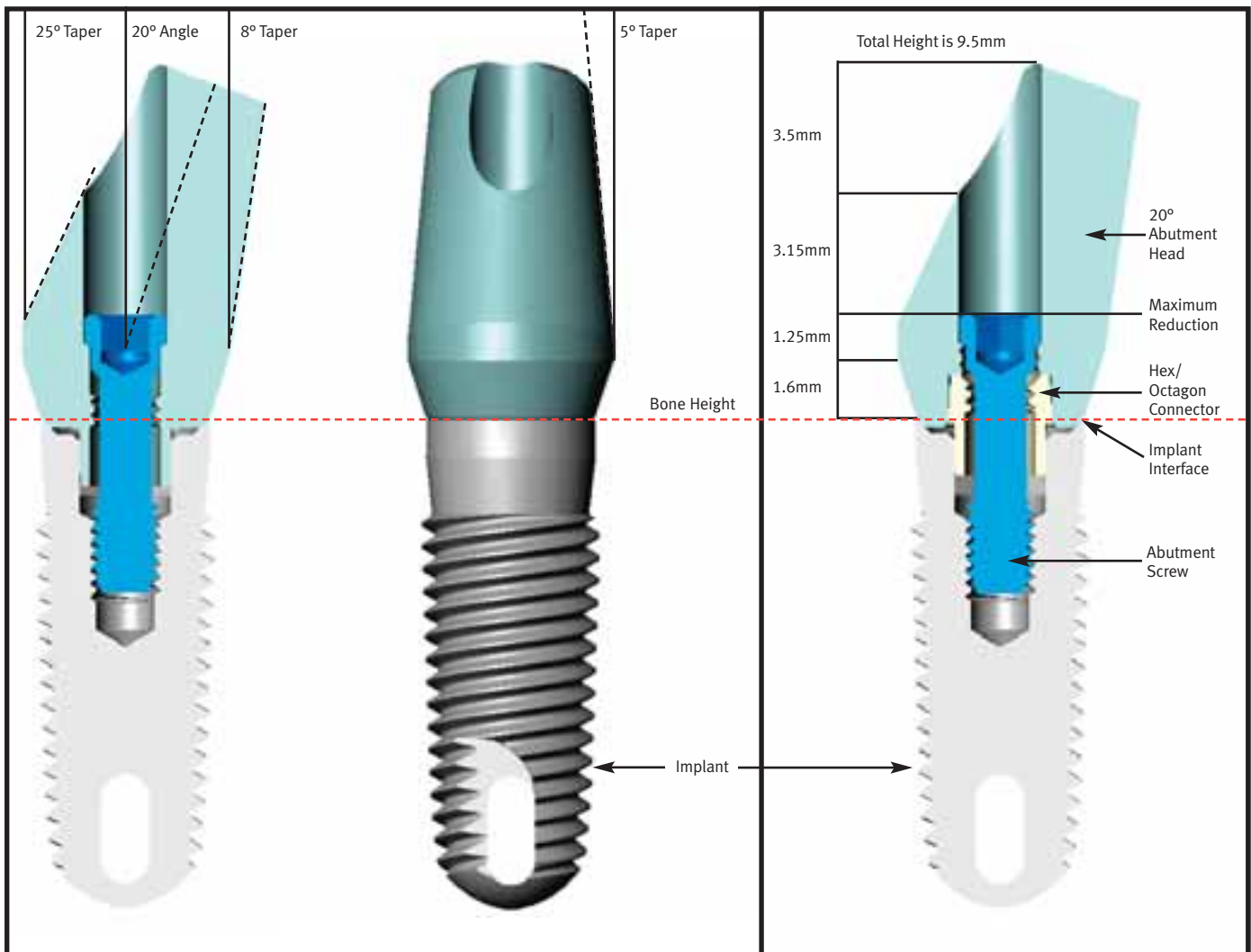



Exposing the top of the implant

Tapered Screw-Vent and Screw-Vent Implants:

- Remove the Healing Collar with the 1.25mmD Hex Tool.

AdVent Implants:

- Remove the Surgical Cover Screws [AVSC] with the 1.25mmD Hex Tool and the Implant Extender [AVE] if present.

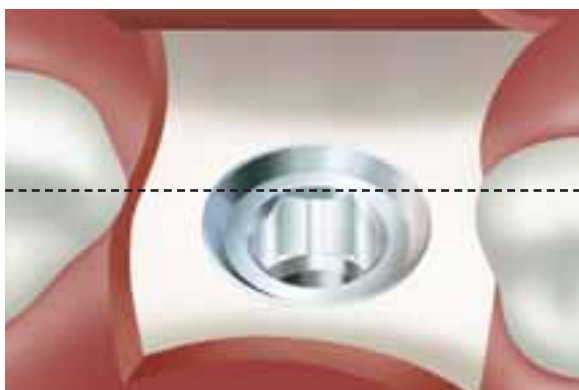

Selecting the type of Angled Abutment



Abutment selection is based upon the orientation of the implant's internal hex in relation to the angulation of the implant, relative to the surrounding anatomical features. If one of the flat surfaces of the implant's internal hex is oriented toward the angulation of the implant, then use the two-piece Angled Abutment as will be discussed in the following pages. If there is no correlation between the angle of the implant and the flat surface of the internal hex of the implant, then select the three-piece Angled Abutment, whose usage is discussed in the following section.



Initially seating the Angled Abutment

Select the two-piece Angled Abutment corresponding to the dimensions of the implant platform being restored.

Remove the abutment from the packaging. Use the 1.25mmD hex tool to remove the abutment screw to allow for easy placement and alignment of the abutment. Carry the component to the implant (analog), interdigitate and press-fit the abutment's hex to the implant's (analog) hex.

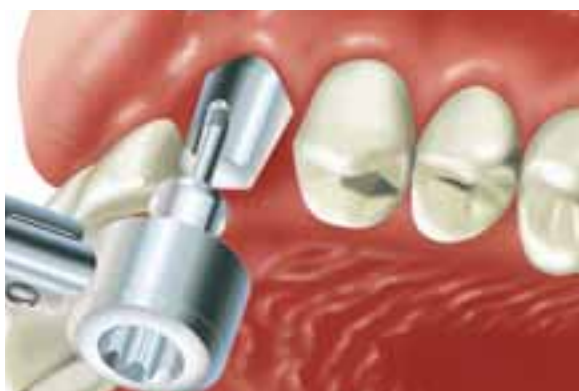

Seating the Angled Abutment

Thread the abutment screw through the access channel within the abutment using the 1.25mmD Hex Tool. Tighten the abutment screw to 30 Ncm with a calibrated torque wrench.



Marking the abutment for desired preparation

Mark the required modifications to achieve appropriate vertical clearance as well as gingival contours. Note: The reduction of the abutment needs to take into consideration the following:

- 1) Type of restoration (for example, a ceramic or metal margin).
- 2) Desired thickness of alloy.
- 3) Desired thickness of veneering material.
- 4) Occlusal considerations such as centric occlusion, protrusive or lateral excursions.



Removing the abutment

Use the 1.25mmD Hex Tool to loosen and remove the abutment screw. Thread the Removal Tool [TLRT2] through the access channel in the abutment and rotate in a clockwise direction. Continued rotation of the tool will result in the abutment lifting off the implant.



Modifying the Angled Abutments

Attach the abutment to an additional Implant Analog located within the Abutment Holder [ABTH]. Modify the abutment with cut-off disks, heatless stone wheels and 12-fluted carbide burs. Use a diamond bur to define the margins. Create a dimple on the buccal surface to help orient the abutment on the implant. Preserve or redefine a flat surface as an anti-rotational feature.



Making final adjustments to the abutments

With a round-end, 12-fluted carbide bur in a high-speed handpiece, make minor modifications to the gingival and vertical contours of the abutments under copious irrigation. After completing final modifications, retighten the abutment screws to the recommended torque. Take a radiograph to confirm that the abutments are fully seated.



Making an impression of the prepared abutment

Block out the screw access channel in the top of the abutment with a medium of choice to prevent the ingress of impression material. Remove excess material so that the block-out is flush with the contour of the abutment. Failure to do so may prevent an accurate impression procedure. Make a conventional, full-arch, crown and bridge impression with an elastomeric impression material, such as vinyl polysiloxane. To insure a proper fit of the finished restoration, the abutment must remain in the patient's mouth after completing the impression procedure. Send the impression to the laboratory to fabricate a porcelain-fused-to-metal prosthesis.



Fabricating the provisional prosthesis

If a diagnostic wax-up was made, make an alginate impression over it and pour the impression in dental stone. Mold a clear acrylic sheet onto the duplicate cast of the diagnostic wax-up according to the manufacturer's instructions. Remove the mold from the cast and flow temporary material into the area of the abutment and edentulous space. Lubricate the prepared abutment and then seat the mold onto the abutment in the patient's mouth. After the material sets, remove it from the mouth and trim and polish the resulting provisional prosthesis.



Cementing the provisional prosthesis

Block out the hex hole in the tops of the abutment screw with material of choice. Cement the provisional prosthesis onto the prepared abutment with soft-access cement. Alternatively, lightly lubricate the abutment and fabricate a provisional prosthesis over the abutment chairside with light-curing material. Once the material is cured, remove the provisional restoration from the patient's mouth, trim and polish it prior to cementation of the finished provisional prosthesis onto the abutment.



Pouring the working cast

Pour the standard crown and bridge impression in die stone. An epoxy die may be useful with an extremely thin preparation. Separate the cast from the impression. Use the interocclusal records to articulate the working cast with the opposing-arch cast. Prepare the working cast for fabrication of the wax framework pattern.

Proceed to common procedures for fabricating the framework pattern on page 49

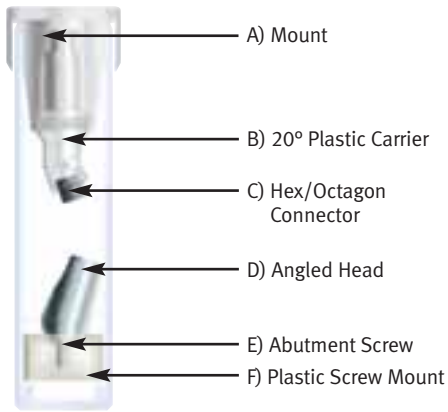

Rotate and pull to remove the sealed outer cap. Tilt the vial and remove its contents. Unthread the plastic carrier to remove it from the acrylic mount.



Carry the connector on the 20° plastic carrier to the site. Rotate and align the carrier until the connector's hex interdigitates with the implant's hex.



Press-fit the connector to the implant. Pull the plastic carrier to the side and remove it from the connector.



Use the 1.25mmD Hex Tool to remove the angled head by unthreading the abutment screw from the screw mount.



Align and interdigitate the angled head, connector and implant. Press-fit the angled head with finger pressure.



Insert the screw through the angled head and connector, then thread it into the implant with the Hex Tool.



Torque the abutment screw to 30 Ncm with a 1.25mmD Hex Tool and calibrated torque wrench.

Three-piece Angled Abutment System — Removing the abutment



Unthread the Abutment Screw [AH20S] from the implant with the Hex Tool.



Thread the Removal Tool [TLRT2] through the angled head and connector to disengage them from the implant.



Thread the Removal Tool [OHRT] through the angled head to disengage it from the connector.



Initially seating the three-piece Angled Abutment

Use standard laboratory procedures to fabricate the implant level soft tissue working cast from the open- or closed-tray impression. The 20° Angled Abutment comes packaged on a carrier angled at 20° to aid in the correct placement of the connector and angled head.

Use the angled carrier to gently position and place the connector:

- Rotate the carrier which simulates the final position of the angled head, to obtain optimum orientation of the connector.
- Align the hexagon of the connector with the hexagon of the Implant Analog and press-fit the connector into position.
- Pull the angled carrier to the side and remove it from the connector.



Initially seating the three-piece Angled Abutment

Visually determine the optimal rotational position of the angled abutment head. If the angled carrier was aligned correctly at the time the connector was placed, the angled head will be in its correct orientation. Place the abutment head on the connector by interdigitating the octagon in the bottom of the head component with the mating octagon on the top of the connector.

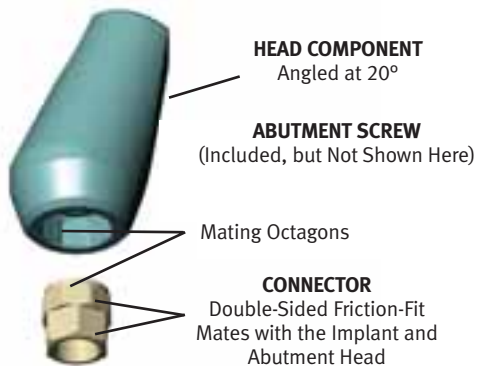

Reorienting the abutment head component

Remove the abutment head from the connector. Mark the buccal facet of the connector with a felt-tipped pen to help visualize its correct reorientation. Rotate the head **counter-clockwise** 1/8 of a turn until one facet of its internal octagon aligns with the next adjacent facet of the mating octagon on top of the connector. Interdigitate the octagons and place the head onto the connector. This allows orienting the head to eight positions at 45° increments. If further adjustment is required remove the combined abutment head and connector from the working cast with the Removal Tool [TLRT2]. Rotate assembly 1/6 of a turn **clockwise** until one facet of the connector's bottom hex aligns with the next adjacent facet of the Implant Analog's hex. Interdigitate the hexes and replace the abutment onto the implant. This allows orienting the base to six positions at 60° increments.



Tightening the abutment screw

Once the Angled Abutment head is placed in the optimal position for the case, insert the abutment screw through the angled head, and thread it through the connector and into the Implant Analog with the 1.25mmD Hex Tool.

Finger-tighten the abutment screw, then tighten to 30 Ncm with a calibrated torque wrench.



Modifying the Angled Abutment

Attach the abutment to an additional Implant Analog located within the Abutment Holder [ABTH]. Modify the abutment with cut-off disks, heatless stone wheels and 12-fluted carbide burs. Use a diamond bur to define the margins. Create a dimple on the buccal surface to help orient the abutment on the implant. Preserve or redefine a flat surface as an anti-rotational feature.



Fabricating the provisional prosthesis

Replace the abutment on the working cast and make final adjustments. Remove the soft tissue material from the working cast if necessary. If a diagnostic wax-up was made, make an alginate impression over it and pour the impression in dental stone. Mold a clear acrylic sheet onto the cast of the diagnostic wax-up according to the manufacturer's instructions. Remove the mold from the cast. Block out the screw access hole and lubricate the abutment and working cast, then flow temporary material into the area of the abutment and missing tooth in the mold. Seat the mold onto the cast containing the prepared abutment. Trim the resulting provisional prosthesis and return it with the prepared abutment to the dentist.



Removing the Angled Abutment

A Removal Tool [TLRT2] is required to disengage the Angled Abutment's friction-fit connection once the assembly has been fully seated. Remove the abutment screw with the 1.25mmD Hex Tool. Insert the Removal Tool through the head component, thread it through the connector and into the Implant Analog until the abutment assembly lifts out of the working cast.

Send the prepared abutment and provisional prosthesis to the clinician for placement.



Placing the final abutment

Sterilize the prepared, assembled Angled Abutment before placing it into the patient's mouth. Interdigitate the hexagons and press-fit the abutment assembly to the implant. Insert the abutment screw into the Angled Abutment assembly, thread it through the assembly and into the implant with the Hex Tool. Tighten the abutment screw to 30 Ncm with a calibrated torque wrench. Take an x-ray to confirm that the abutment is fully seated.

Wait ten minutes, then retighten the abutment.



Modifying the abutment

Visually determine any further modifications necessary for establishing marginal, labial and vertical contours. Make any modifications to the abutment with copious irrigation, and a round-end diamond or 12-fluted carbide bur in a high-speed handpiece.



Making an impression of the prepared abutment

Block out the access hole to the abutment screw with a light-curing resilient material or gutta-percha to preserve easy access to the screw head. Make a conventional, full-arch, crown and bridge impression with an elastomeric impression material, such as vinyl polysiloxane. Make an impression of the opposing arch and take a bite registration.



Cementing the provisional prosthesis

Cement the prosthesis onto the prepared abutment with soft-access cement. Alternatively, lightly lubricate the abutment and fabricate a provisional prosthesis over the abutment chairside with light-curing material. Once the material is cured, remove the provisional restoration from the patient's mouth, trim and polish, and then cement the finished provisional prosthesis onto the abutment.

Send the impressions and interocclusal records to the laboratory for fabrication of the porcelain-fused-to-metal crown.



Pouring the working cast

Pour the standard crown and bridge impression in die stone. An epoxy die may be useful with an extremely thin preparation. Separate the cast from the impression. Use the interocclusal records to articulate the working cast with the opposing-arch cast. Prepare the working cast for fabrication of the wax framework pattern.

Proceed to common procedures for fabricating the framework pattern on page 49



Fabricating the wax framework pattern

Create the wax framework pattern according to standard crown and bridge procedures.



Spruing, investing and casting the framework pattern

Attach 10-gauge sprue wax with reservoir to the thickest part of the framework pattern. Add an auxiliary sprue and vent to prevent porosity in the casting as needed.

Invest and cast the pattern in noble or high noble ceramic alloy according to the manufacturer's guidelines.



Finishing the cast framework

Divest the cast framework with ultrasonic cleaning and non-abrasive glass bead. Remove the soft tissue replica from the working cast and follow routine laboratory procedures to fit and finish the framework. Seat the finished framework onto the working cast.



Applying the porcelain (veneering material)

Prepare the framework to receive the opaque layer according to routine laboratory procedures.



Finishing the final prosthesis

Apply porcelain to the framework, finish the porcelain, and polish any metal margins according to routine laboratory procedures. Seat the finished prosthesis on the working cast and send it to the clinician for final delivery.



Delivering the final prosthesis

Remove the provisional restoration from the patient's mouth. Retorque the abutment screw to 30 Ncm with a calibrated torque wrench.



Delivering the final prosthesis

Seal the screw access channel in the abutment with cotton pellets and light-curing resilient material or gutta-percha. This will ensure easy access to the screw head. Seat the final prosthesis onto the abutment and confirm fit and contour. Check the occlusion. Verify that no additional finishing or adjustment is required.

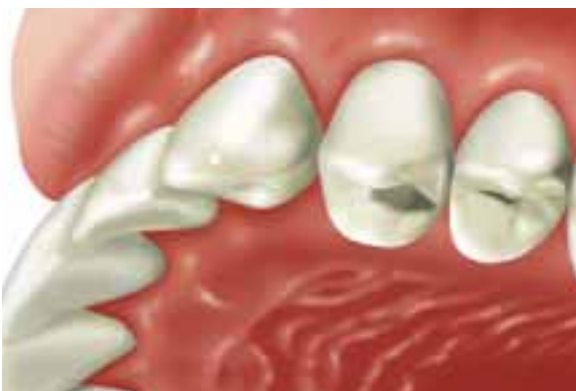

Delivering the final prosthesis

Cement the final prosthesis with cement of choice. To facilitate future retrievability, a soft-access cement may be used. Provide the patient with oral hygiene instructions prior to release.



Restorative Manual



“Cast-To” Gold Abutment System

“Cast-To” Gold Abutments are used to fabricate implant-level, custom cast restorations that provide subgingival margins for esthetics, reduced height for vertical occlusal clearance and/or custom angles. These abutment assemblies consist of a hex-engaging gold base, an abutment screw and a castable press-fit Plastic Sheath.

The press-fit Plastic Sheath is modified and incorporated into the wax framework pattern. After investing, the wax and Plastic Sheath are burned out of the pattern following the lost wax process. When molten alloy is cast into the investment mold, the base component is incorporated into the casting and provides a machined interface that mates directly with the implant. The finished casting can be used as a custom abutment that receives a cemented single- or multiple-unit restoration, or it can be veneered and used as a single-unit, screw-retained, combined abutment-and-crown. Caution: Multi-unit, screw-retained restorations cannot be fabricated with these abutments; use non-engaging abutments for these types of restorations.

The gold base is fabricated from a non-oxidizing alloy that promotes chemical adhesion of the cast alloy, but does not permit the adhesion of porcelain. Therefore, a porcelain bonding alloy must be added to all areas of the gold base where porcelain veneering is desired.

Screw-Retained Crown



Custom Angled Abutment



Custom Abutments



Abutment for the Internal Hex Implant, 3.5mmD platform



“Cast-To”
Gold Abutment
[HLA3G]

Abutment for the Internal Hex Implant, 5.7mmD platform



“Cast-To”
Gold Abutment
[HLA5G]

Abutment for the Internal Hex Implant, 4.5mmD platform



“Cast-To”
Gold Abutment
[HLA4G]

Abutment for the AdVent Implant, 4.5mmD platform



“Cast-To”
Gold Abutment
[AVGA]

Abutment for the Wide Platform AdVent, 5.7mmD platform



“Cast-To”
Gold Abutment
[HLA5G]

“Cast-To” Gold Abutment for Tapered Screw-Vent, Screw-Vent and AdVent Implant Systems

“Cast-To” Gold Abutments [HLA3G, HLA4G, HLA5G AND AVGA] for internal hex implants have a low profile collar that allows for an esthetic, subgingival connection above the friction-fit abutment/implant interface.

The abutments are packaged with a gold base, a 3.8mmD Plastic Castable Sheath [OPS] and an Abutment Screw [MHLAS] for [HLA3G, HLA4G, HLA5G] and [AVHLS] for the standard platform (4.5mmD) AdVent Abutment [AVGA]. Once all the restorative components are in place, the minimum vertical clearance between the implant interface and the opposing dentition is 3.75mmL and 3.5mmL, respectively (as shown below).

These abutments require a Removal Tool [TLRT2] to disengage their friction-fit once the abutments are fully seated on the implants or implant analogs.

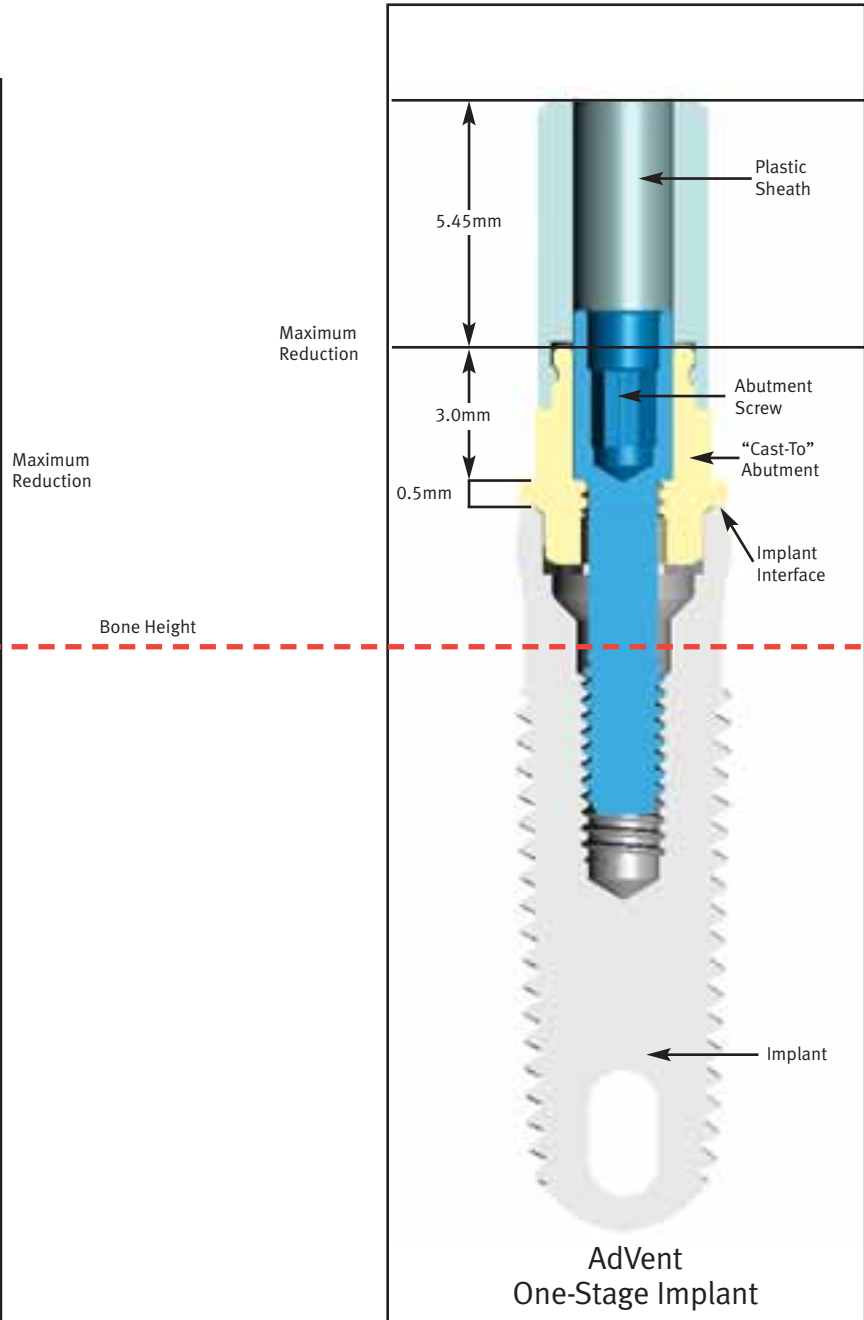
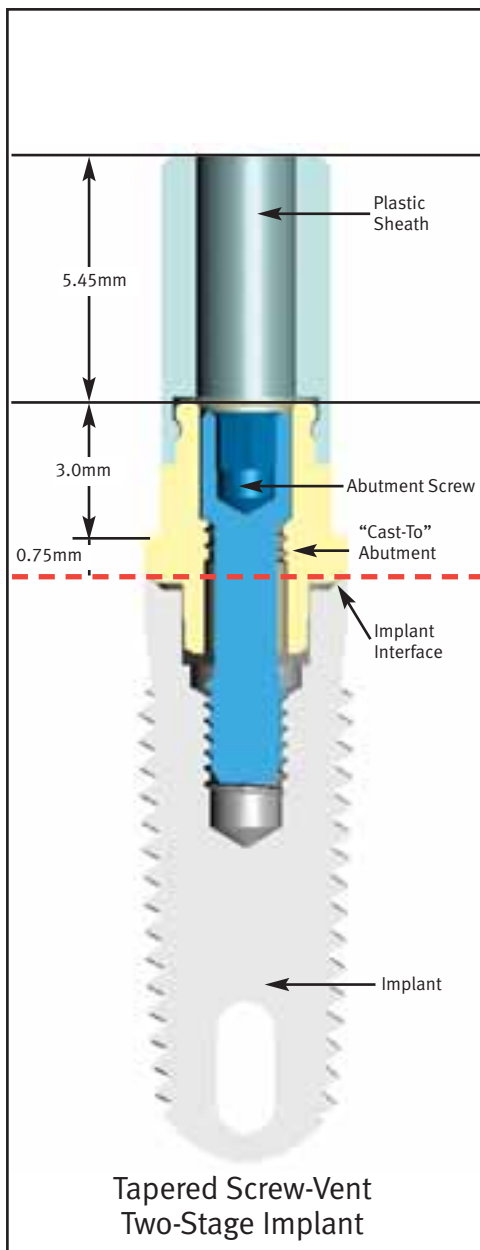

Maximum Reduction

Maximum Reduction

Bone Height



Selecting the “Cast-To” Gold Abutment

Fabricate the working cast utilizing one of the transfer procedures mentioned in the previous section. “Cast-To” Gold Abutments for internal hex [HLA3G, HLA4G, HLA5G and AVGA] implants consist of a hexed, gold “Cast-To” Abutment body, abutment screw and 3.8mmD press-fit Plastic Sheath [OPS].

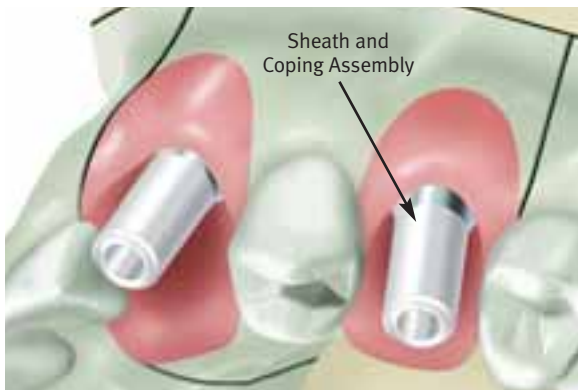

Attaching the abutments and Plastic Sheaths

Carefully seat the assemblies onto the Implant Analogs in the working cast. Thread the abutment screws through the abutment assemblies and into the Implant Analogs with the 1.25mmD Hex Tool. To fully seat the friction-fit abutments, tighten the abutment screws to 30 Ncm with a calibrated torque wrench. Once seated, utilize the Removal Tool [TLRT2] to retrieve the abutments from the Implant Analogs, as required.



Trimming the Plastic Sheaths

Visually determine the modifications needed to provide adequate clearance for adjacent and opposing dentition. Consult with the clinician to determine any additional modifications needed for the case design. The case illustrated here involves the fabrication of a cast abutment on the canine and a screw-retained, combination abutment-and-crown on the second premolar. Section the Plastic Sheaths with a cutting disk to obtain the correct vertical and interproximal clearance.



Fabricating the framework pattern

Use wax and/or acrylic burnout resin to incorporate the modified gold base and Plastic Sheaths into the pattern. Build up the final contours of the pattern with crown and bridge wax.

As an option to using the Plastic Sheaths and abutment screws:

- Secure the abutments to the Implant Analogs with the Waxing Screws [MTWSD for internal hex implants].
- Lightly lubricate the Waxing Screw.
- Use wax and or acrylic burnout resin and fabricate the framework pattern around the screw and directly to the abutments.



Removing the framework pattern

Remove the abutment screw with the 1.25mmD Hex Tool. Thread the Removal Tool [TLRT2] through the abutment pattern and into the implant to remove the pattern from the Implant Analog.

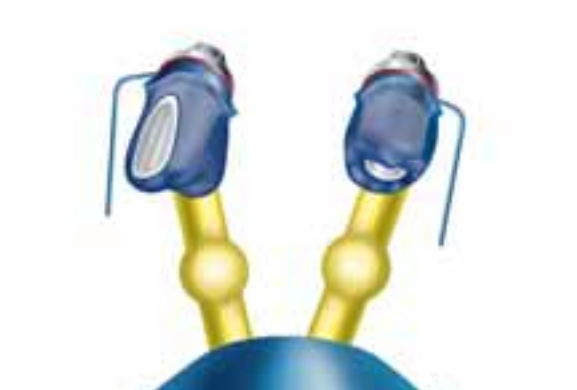

Spruing, casting and divesting of the metal framework

Attach 10-gauge sprue wax with reservoirs to the thickest part of each unit. Carefully apply a thin layer of wax or burnout resin at the junction of the abutment and the Plastic Sheath to ensure a smooth casting. Add auxiliary sprues and vents to prevent porosity in the casting as needed. Do not use a debubbler when investing the gold or plastic components.

When casting to gold components, the casting alloy must not exceed a casting temperature of 2350°F/1288°C. Cast the framework pattern according to conventional techniques utilizing a two-stage burnout, which is standard practice with patterns containing plastic or resin. The burnout temperature should not exceed 1500°F/815°C, with a hold time of no longer than 1 hour. Utilize high noble or noble alloy with a compatible investment material, as described in the manufacturer’s guidelines.



Divest the casting; chemical investment removers may also be used with gold components. To ensure that the fitting surface of the incorporated copings are not damaged, protect the abutment interface while blasting the abutment with glass bead. Clean the casting in an ultrasonic unit. Refine the screw access holes within the casting by hand-rotating the Reamer for “Cast-To” Abutments [MRI for HLA3G, HLA4G and HLA5G; PR for AVGA].



Finishing the metal framework

Confirm that a passive fit has been achieved on the corresponding Implant Analog in the working cast. The soft tissue replica can be removed from the working cast to provide visual access to the cast abutment/implant analog connection, if desired. Use the abutment screws to secure the finished cast metal abutments to the Implant Analogs in the working cast and return it to the clinician for try-in. Make sure the clinician has the appropriate Removal Tool [TLRT2] to disengage the incorporated “Cast-To” Gold Abutments from the working cast.



Removing the healing components

Unthread the abutment screws with the 1.25mmD Hex Tool. Remove the abutments from the working cast with the appropriate removal tool. Sterilize the components according to standard clinical procedures. Remove the provisional restoration from the patient's mouth. Unthread the Healing Collars or Surgical Cover Screws with the 1.25mmD Hex Tool. Clean and sterilize the components for placement after the cast abutment try-in.



Placing the cast abutments

Interdigitate the hex of each cast post with its corresponding implant, then use the 1.25mmD Hex Tool to thread the abutment screw through the cast post body and into the implant. Tighten the abutment screw to 30 Ncm with a calibrated torque wrench. Wait ten minutes, then retighten the cast posts to 30 Ncm. Take a radiograph to verify that the cast posts are completely seated.



Making the adjustments to the cast abutments

The premolar will be a screw-retained, combination post-and-porcelain-fused-to-metal crown. The canine will be a cast abutment with a porcelain-fused-to-metal crown cemented onto it. To make allowance for the different restorative procedures, make the required modifications to the gingival, occlusal and interproximal contours of the cast abutments with a round-end diamond or 12-fluted carbide bur in a high-speed handpiece, and under copious irrigation.

Follow appropriate procedures for each type of restoration listed below. Note that two options are available for restoring the cast abutment in the canine position.



Canine: cemented crown — option 1

Make a crown and bridge impression of the seated cast post. Place the provisional fabricated by the laboratory or chairside on the cast abutment. Return the impression to the laboratory for the fabrication of a porcelain-fused-to-metal prosthesis according to routine laboratory procedures for crown and bridge.

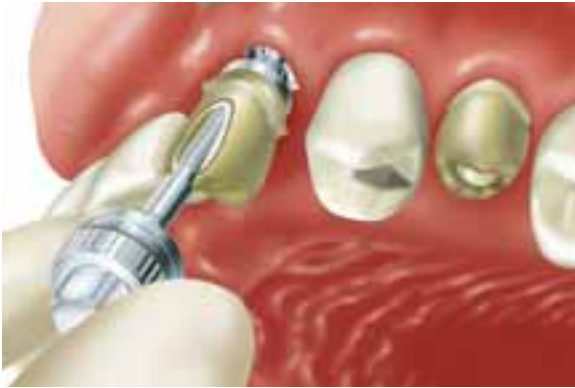

Canine: cemented crown — option 2

Unthread the abutment screw with the Hex Tool. Remove the abutment post from the mouth with the appropriate Removal Tool [TLRT2]. Sterilize the cast post assembly according to standard clinical procedures and reseat it on the working cast. Select a tooth shade for the restoration, reseat the healing components with the 1.25mmD Hex Tool and replace the provisional restoration in the patient’s mouth. Send the working cast with the cast post to the laboratory for fabrication of the final porcelain-fused-to-metal restoration. The laboratory can use the cast post as a die to fabricate the coping.



Canine: cemented crown — option 2

Prepare the abutment for fabrication of a porcelain-fused-to-metal restoration. Seal the abutment screw access hole of the cast post with a resilient material. Lubricate the cast post and flow autopolymerizing burnout resin over the contour of the cast post above the proposed restoration finish line. Do not use crown and bridge wax directly on the cast post, as it can pull away from the metal and cause inaccuracies in the final metal coping.



Canine: cemented crown — options 1 & 2

Build up the final contour of the coping with crown and bridge wax. Attach 10-gauge sprue wax to the thickest part of the coping. Invest the coping:

- Option 1: Follow standard setting expansion of the investment material when using a stone die.
- Option 2: Allow for a greater setting expansion of the investment material when using a metal die (abutment). This will compensate for the lack of die spacer used on the abutment when the coping pattern was fabricated.

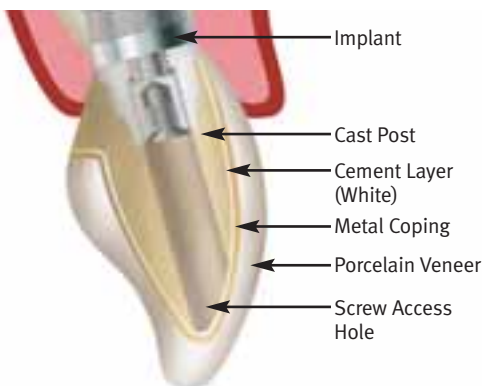

Canine: cemented crown — options 1 & 2

Fabricate the porcelain-fused-to-metal crown according to routine laboratory procedures. The result will be a three-piece prosthesis consisting of a screw-retained post (two-piece) for the implant, and a porcelain-fused-to-metal crown that will be cemented onto the post.

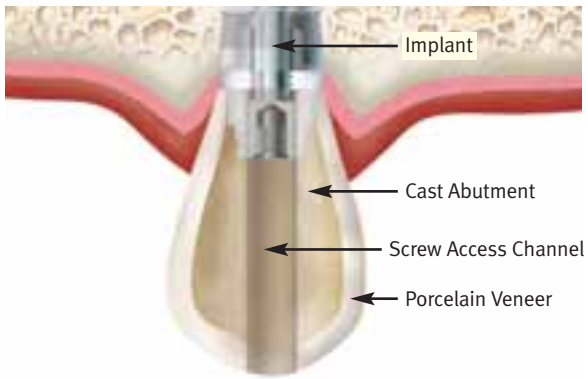

Premolar: combination abutment and crown

Unthread the abutment screw with the Hex Tool. Remove the abutment from the mouth with the appropriate Removal Tool [TLRT2]. Sterilize the cast abutment assembly according to standard clinical procedures and reseat it on the working cast. Select a tooth shade for the restoration, reseat the healing component with the Hex Tool and replace the provisional restoration in the patient's mouth. Prepare the abutment removed from the premolar position for porcelain application. Follow routine laboratory procedures for a screw-retained, combination abutment-and-crown prosthesis. Do not allow porcelain to enter the screw access channel of the prosthesis.



Canine and premolar

Carefully polish the finished prostheses without damaging the machined interfaces or crown margins. Attach additional Implant Analogs to the prostheses prior to polishing.

Reseat the prostheses on the working cast and return them to the clinician for final delivery.



Delivering the final prosthesis

Remove the prostheses and abutment from the working cast and sterilize them. Remove the provisional restorations and use the Hex Tool to remove the healing components.

Interdigitate the hexes of the abutments and the hexes of their corresponding implants. Thread the abutment screws through the abutment bodies and into the implants with the Hex Tool. Tighten the abutment screws to 30 Ncm with a calibrated torque wrench. Wait ten minutes, then retighten the screws. Take a radiograph to verify complete seating of the cast abutment and combined abutment-and-crown.

Premolar: Confirm the fit, contour and occlusion of the restoration, and make any needed final adjustments. Insert small cotton pellets or other resilient material into the screw access channel to ensure access to the screw head, then fill the channel with composite resin material to complete the contour and esthetics of the restoration.

Canine: Fill the screw access channel of the custom abutment post with cotton pellets to ensure access to the screw head, then fill the channel with a light-curing resilient material or gutta-percha. Confirm the fit, contour and occlusion of the restoration, and make any needed final adjustments. Cement the final prosthesis with a cement of choice. To facilitate future retrievability, a soft-access cement may be used.

Provide the patient with oral hygiene instructions prior to release.





Restorative Manual



PureForm Ceramic System

The *PureForm Ceramic System* is designed to fabricate single-unit fixed restorations in areas of the mouth with high esthetic demands, specifically the anterior and premolar regions. This product should not be splinted together for multiple-unit cases, removable partial dentures or bridgework.

The *PureForm Ceramic System* consists of a Ceramic Coping (Fig. 1), a titanium alloy metal Core Abutment (Fig. 2) and an abutment (retaining) screw (Fig. 3).

The Ceramic Copings are molded from a material with a base composition of 70% Alumina and 30% Zirconia. The material has an A2 shade which is added to the material prior to the forming and sintering process. The copings are molded to resemble the proportionally undersized shape of natural teeth to lend support to the porcelain veneering material: central incisor, lateral incisor, canine and premolar. Two additional shapes are available to assist with angled implants, molded to form a 17° preangled lateral incisor and a 17° preangled central incisor. The undersized shape of the copings allows the technician in many cases to apply an even thickness of ceramic veneering material without further modification. In case the Ceramic Copings need to be reduced, they can be prepared to a wall thickness of 0.5mm. Internally the coping has a conical shape with one flat surface on the buccal/labial wall. This flat will interdigitate with the corresponding flat of the Try-in and Core Abutment.

The Core Abutment is available for the *Tapered Screw-Vent* and *Screw-Vent* 3.5mmD and 4.5mmD platforms. Each Core Abutment has a base with a hex configuration having one-degree tapered flats, enabling it to friction-fit to the hex of the implant. The profiled upper portion (cuff) flares to a standard 4.5mmD and can be used with any shape of Ceramic Coping. The height of the Core Abutment is 4.9mm above the cuff which is available in two heights: 0.5mm and 1.5mm. The conical upper portion has a flat surface on one side which is oriented to the buccal/labial when connecting to the implant. The Core Abutment comes packaged with the Abutment Screw [MHLAS].

To assist the technician and the clinician in the selection of the correct height of Core Abutment and Ceramic Coping, the following Try-in Kits are available:

- 1) Abutment Try-in Kit [CAHKIT]: Metal Try-ins manufactured to similar specifications as the Core Abutments. Supplied in the two available heights and implant platform diameters (4 pieces in total). They are color-coded to ensure ease of use. The kit comes packaged with the two separate abutment screws.
- 2) Plastic Try-in Kit [PTKIT]: Plastic components molded to the same shapes as the six Ceramic Copings. These parts are used to determine shape, contour and angle of the required Ceramic Coping, as well as if the ceramic abutment system is the best restorative option prior to acquiring the components.

Contraindications

Not for screw-retained prosthetics. Not to be used to restore molars. Metal Core Abutment should not be prepped. Plastic Try-ins should not be used for temporary restorations.

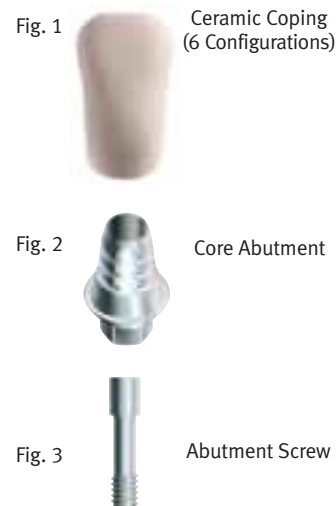

3.5mmD Platform
Internal Hex Implant



Implant Top



4.5mmD Platform
Internal Hex Implant

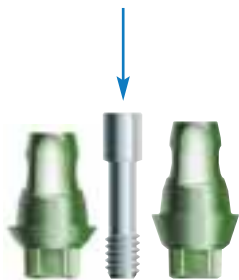

Core Abutment Try-in Kit
for Internal Hex
[CAHKIT]

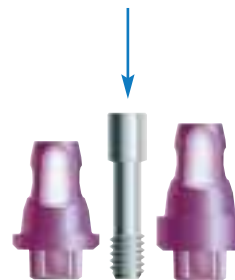

Core Abutments
for Internal Hex



[CAH3S]

[CAH3L]

[CAH4S]

[CAH4L]

Plastic Try-in Kit
[PTKIT]



Plastic Try-in
Large Incisor
[PTLG]



Plastic Try-in
Large Incisor, 17°
[PTLG17]



Plastic Try-in
Small Incisor
[PTSM]



Plastic Try-in
Small Incisor, 17°
[PTSM17]



Plastic Try-in
Canine
[PTCN]



Plastic Try-in
Premolar
[PTPM]

Ceramic
Copings



Ceramic Coping
Large Incisor
10.5mmL
[CCLG]



Ceramic Coping
Large Incisor, 17°
10.4mmL
[CCLG17]



Ceramic Coping
Small Incisor
9.8mmL
[CCSM]



Ceramic Coping
Small Incisor, 17°
9.6mmL
[CCSM17]



Ceramic Coping
Canine
10.8mmL
[CCCN]



Ceramic Coping
Premolar
8.8mmL
[CCPM]



Aligning the implant

Align the flat of the implant's internal hex at the time of placement. This is achieved by orienting the flat of the preattached Fixture Mount/Transfer toward the buccal or labial surface, which aligns the flat of the internal hex of the implant in the correct orientation.

A Surgical Try-in Pin [CCSTP] is also available for use after the pilot drill to help with proper spatial alignment of the implant.

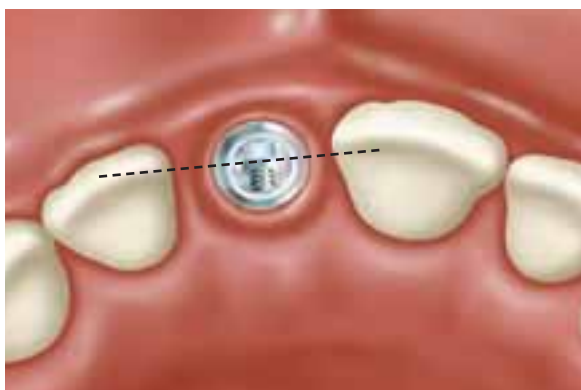

Aligning the implant

The above step will help ensure that the flat of the abutment is aligned properly for the restoration. The *PureForm* Ceramic System consists of a metal abutment (core) and a ceramic tooth-shaped coping that is indexed to the flat on the abutment. Porcelain is applied directly to the coping and fired. No wax-up or casting is required to create a coping.



Placing the healing component

Place a Healing Collar or provisional restoration in a single-stage procedure to accelerate soft tissue contouring, if so desired. Alternatively, these can be placed at implant uncovering following the traditional two-stage protocol. Once hard and soft tissues have healed, remove the Healing Collar or provisional restoration to proceed with the restorative phase.



Attaching the transfer

Attach the implant-level transfer and tighten the screw using a 1.25mmD Hex Tool and finger-pressure. Block out the screw access channel to prevent the ingress of impression material.



Making an impression

Record a traditional implant-level impression. An elastomeric impression material is recommended, such as vinyl polysiloxane. Inject light-body impression material around the transfer and fill the closed tray with heavier-body impression material. Make a full-arch impression, and allow the material to set according to the manufacturer's recommendations before removing.

Unthread the transfers from the implants in the patient's mouth. Make interocclusal records and an impression of the opposing arch. Send the impressions and transfer assemblies to the laboratory for fabrication of the working casts. Replace the healing collar and/or the provisional restoration on the implant.



Fabricating the working cast

Use soft tissue replication material when pouring the impression. Lubricate the impression with a separating medium, and place soft tissue replication material around the junctions of the assembled Implant Analogs and the transfers inside the impression. Take care not to cover the retention grooves of the Implant Analogs with the material. After the material sets, use a sharp instrument to create mechanical retention or undercut areas.

Pour the impression in the traditional manner with die stone and allow to set.



Selecting the Core Abutment

Select the appropriate Core Abutment diameter that corresponds to the implant platform being restored. Two cuff heights are available for each diameter: 0.5mm and 1.5mm to allow for placement of the junction of the Core Abutment and the Ceramic Coping at the desired subgingival level. A set of color-coded Metal Abutment Try-ins is available: green - 3.5mmD platform and purple - 4.5mmD platform.

Seat the Core Abutment or Abutment Try-in of choice on the working cast with the retaining screw. Orient the flat of the abutment or Try-in to the buccal surface.



Removing the Core Abutment

The laboratory technician has the choice to continue the prosthesis fabrication on the Try-in component or place the final abutment on the working cast.

The Try-in component does not have a friction-fit connection to the Implant Analog. If using the Core Abutment, which has a friction-fit, use the Hex Tool to loosen and remove the Abutment Screw [MHLAS]. Thread the Removal Tool [TLRT2] through the access channel in the abutment and rotate in a clockwise direction. Continued rotation of the tool will result in the abutment lifting off the implant.





Selecting the Ceramic Coping

Use the replicas provided in the Plastic Try-in Kit [PTKIT] to select the coping closest to the size and geometry of the final tooth being replaced. The plastic replicas in the Try-in Kit represent the size and shape of the Ceramic Copings.

Six shapes are available: Straight Large Incisor [PTLG] and 17° Angled Large Incisor [PTLG17]), Straight Small Incisor [PTSM] and 17° Angled Small Incisor [PTSM17], Canine [PTCN] and Premolar [PTPM].

Each Ceramic Coping flares from 4.5mmD at the base and will fit any size Core Abutment.



Ordering the Ceramic Coping

Order the Ceramic Coping that corresponds to the Try-in selected.

Part numbers are etched on each Plastic Try-in replica for easy identification and reference. A table inside the Try-in Kit lists the corresponding Ceramic Coping part numbers for easy reference and ordering.



Orienting the Ceramic Coping

Remove the coping from the plastic holder. Align the flat on the Try-in or Core Abutment with the flat inside the Ceramic Coping.



Preparing the Ceramic Coping

Reduce the Ceramic Coping to the correct dimensions to allow for the required thickness of porcelain veneering material. Use the appropriate finishing burs to finesse the profile as required. The plastic holder supplied with the coping is used to assist holding the coping while trimming.

Care must be taken not to overheat the Ceramic Coping during preparation.

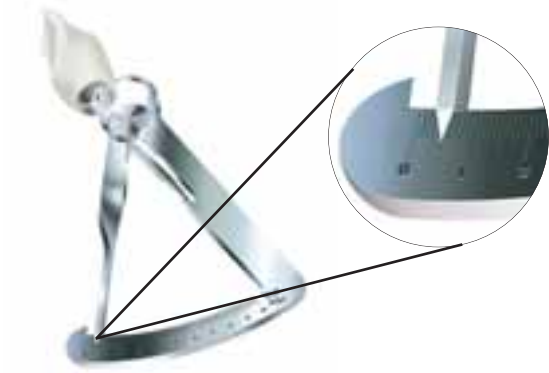

Trimming the Ceramic Coping

Utilize standard laboratory procedures to ensure the additional trimming of the Ceramic Coping does not reduce the wall thickness to less than 0.5mm.

Sand blast the surface of the coping with 120 micron aluminum oxide at 35-38 PSI and clean the coping with steam or distilled water in the ultrasonic cleaning unit.



Applying porcelain

When applying porcelain to the coping follow the manufacturer's guidelines for application of color modifiers, ceramic build-up and firing temperatures. The coefficient of thermal expansion of the Ceramic Coping is $8.1 \times 10^{-6}/^{\circ}\text{C}$ between 0-500°C (932°F).

Applied porcelains should be selected to accommodate for the parameters of the underlying coping.



Finishing the restoration

Complete the restoration using conventional laboratory techniques for "full ceramic" crowns.



Tightening the Core Abutment

Remove the prosthesis from the working cast. Unthread the abutment screw with the 1.25mmD Hex Tool and remove the Core Abutment. Sterilize the components according to standard clinical procedures.

Remove the healing components and seat the Metal Core Abutment into the implant. Be sure the flat of the Core Abutment is oriented to the buccal/labial. Tighten the abutment screw to 30 Ncm with a calibrated torque wrench. Take an x-ray to confirm that the Core Abutment is fully seated.



Delivering the final prosthesis

Block out the screw access channel in the abutment with cotton pellets and light-curing resilient material or gutta-percha. This will ensure easy access to the screw head.



Delivering the final prosthesis

Seat the final prosthesis onto the abutment. Confirm esthetics, fit, contour and check the occlusion. Verify that no additional finishing or adjustment is required.

Apply cement and seat the crown onto the Core Abutment in a typical fashion as when seating any all ceramic crown on an implant abutment or natural tooth.

Note: Cements that are known to expand during setting are not recommended.



Delivering the final prosthesis

Adjust the occlusion and bite on the crown after it is cemented. Remove any exuded cement from the margin area.

Provide the patient with oral hygiene instructions prior to release.



Restorative Manual



Tapered Abutment System

Tapered Abutments are used as the transmucosal extension during the fabrication of partially or fully edentulous splinted, screw-retained multiple-unit prostheses. Once connected to the implant, they extend through the soft tissue to create a common screw-receiving platform on which a restorative prosthesis is attached. In esthetic areas the margin of the screw-receiving platform is located slightly subgingival, whereas in the bar type overdentures the platform is normally located 1mm supragingival.

The Tapered Abutment is a one-piece titanium alloy component having a 4.5mmD platform (except the *AdVent Screw* [AVACT]) with a raised central section having 15° tapered walls. This angulation requires implants to be within 30° of parallelism to each other for a splinted prosthesis to have a passive path of draw. Located within the raised area are the threads which receive the fixation screw for holding down the prosthesis. Below the internally threaded area of the abutment is a 1.25mmD matrix (female) hex designed to receive the standard 1.25mmD Hex Tool. Rotation of the Hex Tool to a calibrated 30 Ncm will fully seat the abutment sealing the abutment/implant interface. Each abutment is supplied with a Protective Cap [TATHC] to seal the abutment platform during prosthesis fabrication.

Screw-Retained Denture



Ball Bar Overdenture



Screw-Retained Partial Denture



Abutment for the Internal Hex Implant, 3.5mmD platform



Tapered Abutment [TAC3]

Abutment for the Internal Hex Implant, 4.5mmD platform



Tapered Abutment [TACW3]

Abutment for the Internal Hex Implant, 5.7mmD platform



Tapered Abutment [TA5C3]

Abutment for the AdVent Implant, 4.5mmD platform



Tapered Abutment [AVACT]

Abutment for the Wide Platform AdVent, 5.7mmD platform



Tapered Abutment [TA5C3]

Tapered Abutments are available in a variety of heights depending on the implant type and platform. The 3.5mmD and 4.5mmD platforms of the *Tapered Screw-Vent* and *Screw-Vent* System have abutments in 0.75mm, 2mm, 3mm, 4mm and 5mm heights, whereas the 5.7mmD platform of the *Tapered Screw-Vent* and *AdVent* System has abutments available in 0.75mm, 2mm, 3mm and 4mm heights. The *AdVent* 4.5mmD platform has an Abutment Screw [AVACT] that creates a Tapered Abutment profile without adding any vertical height to the implant. This screw can be used in combination with the *AdVent* Extender [AVE] to add 2mm in vertical height to the implant. In addition, there is a 3mmL Abutment [AVACT3] which can be attached to the *AdVent* Implant.

Tapered abutments are packaged as a one-piece component that when assembled to the implant have a platform diameter of 4.5mm with a central raised section. Once all the restorative components are in place, the minimum vertical clearance between the implant interface and the opposing dentition is 5.4mmL for all platforms of the *Tapered Screw-Vent* and *Screw-Vent* System and 5.7mmD platform *AdVent* System, respectively. The 4.5mmD platform *AdVent* System requires a minimum of 3.4mmL from the top of the implant to the opposing dentition (as shown below).

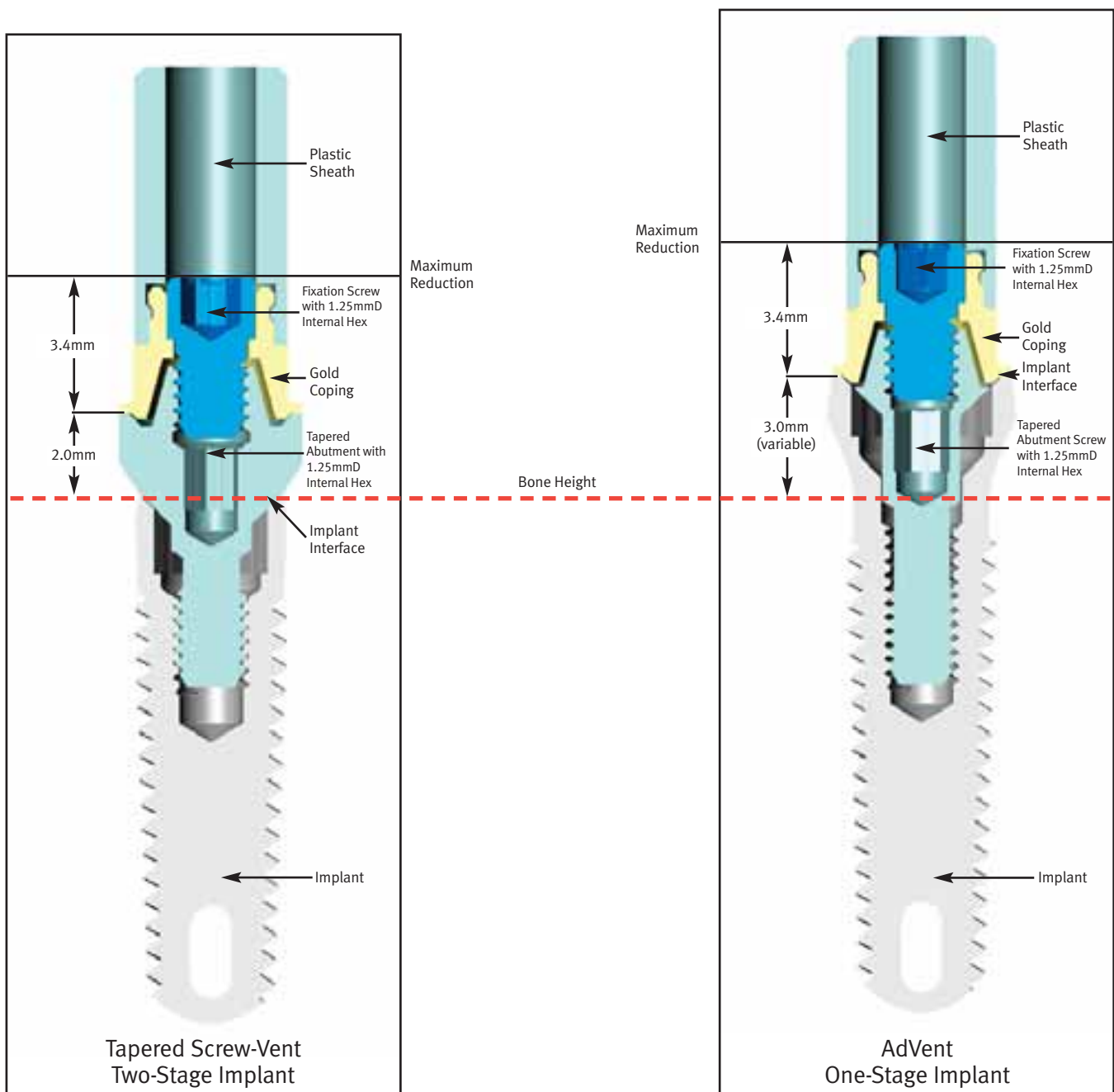

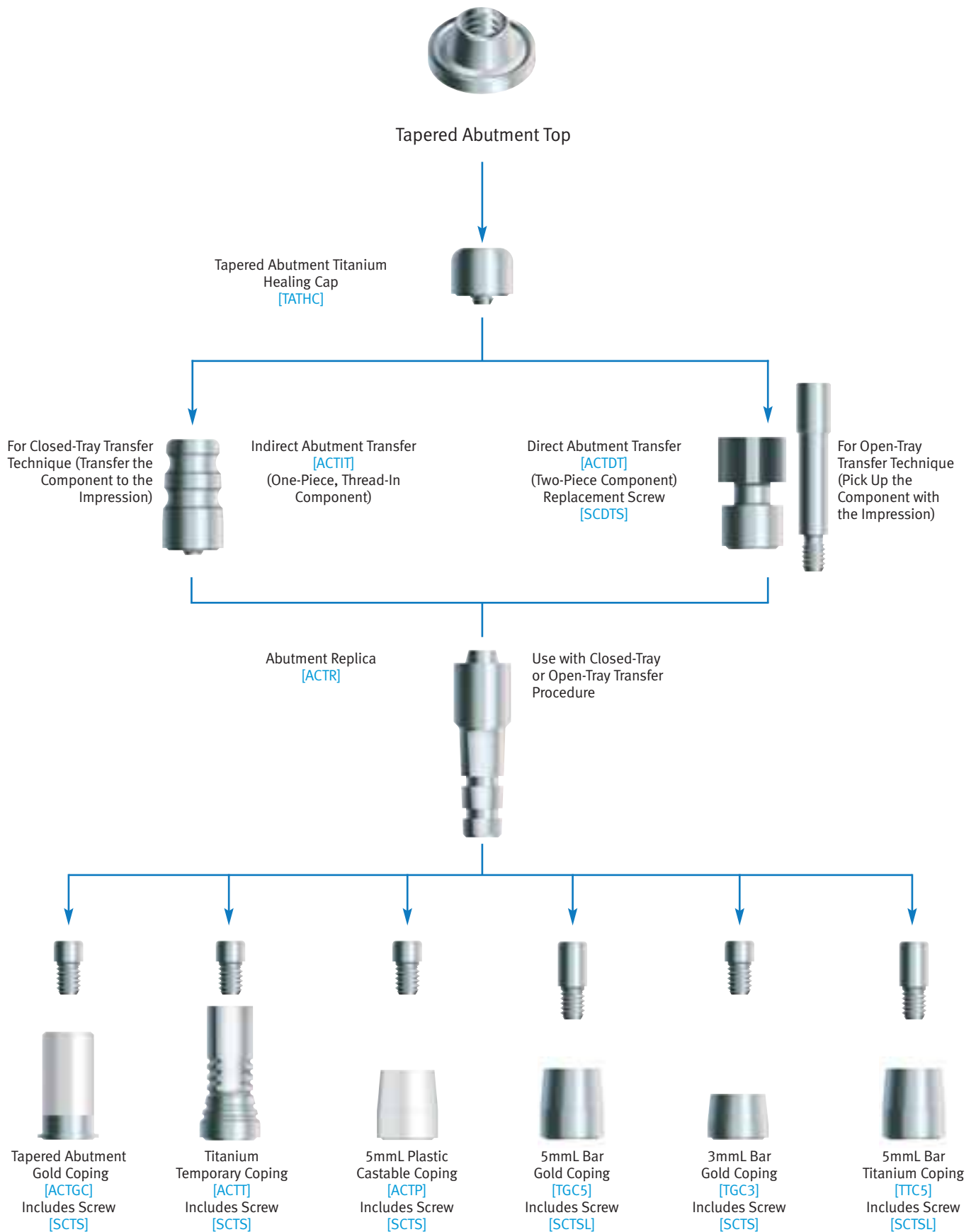



Fabricating the custom tray

Option 1: Open-tray procedure with Direct Transfers

Thread Titanium Healing Caps [TATHC] into the abutments with the Hex Tool. Make a full-arch impression of the Healing Caps and edentulous areas. Send it to the laboratory for fabrication of a working cast and custom impression tray.

Alternatively, select a stock tray and mold the border with greenstick compound material. The patient's existing, modified denture can continue to be worn during the laboratory phase.



Fabricating the custom tray

Pour the impression in dental stone and separate the preliminary cast after it sets.

Block the area above the abutments with baseplate wax to simulate the position of the abutment transfers that will be used.



Fabricating the custom tray

Option 1: Open-tray procedure with Direct Transfers

Fabricate the custom impression tray with autopolymerizing or light-cure tray resin. Create an opening above the abutment area to allow for access to the direct transfer screws.

Option 2: Closed-tray procedure with Indirect Transfers

Fabricate the custom impression tray with autopolymerizing or light-cure tray resin and leave the area above the abutments closed.



Making the transfer impression

Recall the patient when the custom tray is ready. Remove the Healing Caps with the 1.25mmD Hex Tool. Retighten the Tapered Abutments to 30 Ncm with a calibrated torque wrench.

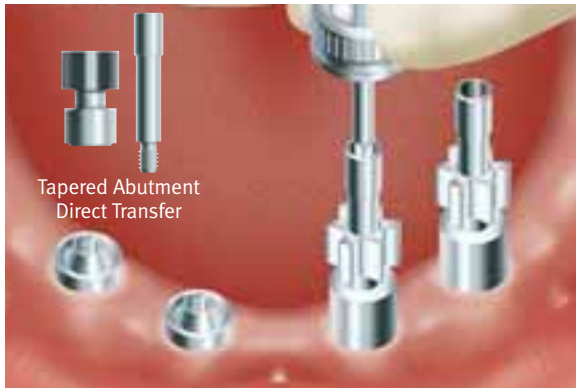

Option 1: attaching the Direct Transfers

Place the body of the Tapered Abutment Direct Transfer [ACTDT] onto the top of the abutment. Insert the transfer screw through the transfer body, thread it into the abutment and finger-tighten with the 1.25mmD Hex Tool. If needed, a Replacement Screw [SCDTS] for the Tapered Abutment Direct Transfer is available.

In areas of limited vertical height, the transfer screws can be shortened with a cutting disc prior to use. During the impression procedure, the Tapered Abutment Direct Transfer bodies will be picked up by the impression material.

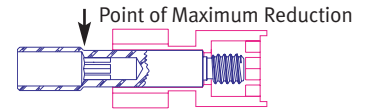

Option 1: verifying fit of the custom tray

Place the open-access tray over the assembled Direct Transfers in the patient's mouth to verify that the screws penetrate through the top of the tray without hindrance. Remove the open-access tray and place a softened piece of baseplate wax on the top of the tray to cover the access opening. This will help contain the impression material. Carefully try in the tray and allow the screws to create access holes through the wax. Remove the tray from the mouth, chill in water, dry, then apply adhesive. Block out the hex holes in the tops of the screws with material of choice to prevent the ingress of impression material.



Option 1: making the impression

An elastomeric impression material is recommended, such as vinyl polysiloxane. Inject light-body impression material around the Direct Transfers and fill the open-access tray with heavier body impression material. Place the loaded tray into the patient's mouth and allow the screws to penetrate through their respective access holes in the hardened baseplate wax. Remove excess impression material from the tops of the screws and allow the impression material to set according to the manufacturer's recommendations. Unthread the screws from the transfers with the Hex Tool and remove them from the patient's mouth. Remove the tray from the mouth. Replace the Healing Caps. The Direct Transfer bodies will be retained in the impression material.



Option 1: completing the transfer procedure

Stabilize the Tapered Abutment Replica [ACTR] with forceps to prevent rotation and insert the screw-receiving end of the replica into the base of the transfer body within the impression material.

Attach the transfer screw to the Hex Tool, and insert it through the respective access hole in the back of the impression tray. Pass the screw through the embedded transfer body and thread it into the attached replica to lock the components together.

Make an opposing-arch impression. Send all the materials to the laboratory for fabrication of a stabilized baseplate with occlusal registration rim.

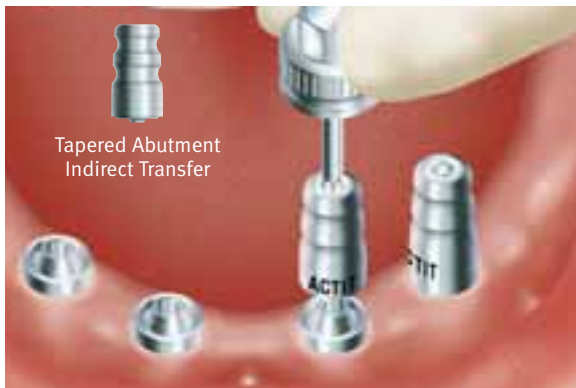

Option 2: attaching the Indirect Transfers

Thread the Tapered Abutment Indirect Transfers [ACTIT] into the tops of the Tapered Abutments with the Hex Tool and finger-tighten.



Option 2: making the impression

Block out the hex holes in the tops of the transfers with material of choice to prevent the ingress of impression material. An elastomeric impression material is recommended, such as vinyl polysiloxane. Inject light-body impression material around the Indirect Transfers and fill the closed tray with heavier-body impression material. Make a full-arch impression, and allow the material to set according to the manufacturer's recommendations before removing. Unthread the Indirect Transfers from the Tapered Abutments with the Hex Tool and set them aside. Replace the Healing Caps.



Option 2: completing the transfer procedure

Thread the transfer onto the Tapered Abutment Replica [ACTR] and finger-tighten with the Hex Tool.

Insert the replica/transfer assembly into the impression hole. A double-click indicates that the transfers are fully seated. Make an opposing-arch impression. Send all the materials to the laboratory for the fabrication of a stabilized baseplate with occlusal registration rim.



Fabricating the verification jig

Pour the impression in die stone. To separate the cast from the impression:

- Open-tray impression: First unthread and remove the transfer screws with the Hex Tool. Remove the tray from the cast.
- Closed-tray impression: Remove the tray from the cast. Unthread and remove the transfer bodies from the cast with the Hex Tool. Gold Copings [ACTGC] will be used to fabricate a stabilized baseplate and occlusal registration rim. These components consist of the metal coping, fixation screw [SCTS] and 3.8mmD press-fit Plastic Sheath [OPS]. Attach the cylinders to the abutment replicas with Waxing Screws [SCWS] to maintain access. Set the coping fixation screws and Plastic Sheaths aside for later use.



Fabricating a verification jig

Block out undercuts beneath the copings with baseplate wax. Lubricate the working cast. Lute the copings together with autopolymerizing or light-cure resin. To prevent distortion from contraction, section the pattern between the copings with a thin separating disk, then re-lute the sections together. To confirm a passive fit, remove the waxing screws from the pattern and reattach the framework pattern to the most distal abutment replica with a single screw and finger-tighten with the Hex Tool. Verify that the remaining copings within the framework pattern rest passively on the abutment replicas. Send the resin framework pattern to the dentist with the coping fixation screws for patient try-in. A passive fit will confirm that an accurate transfer has been achieved.

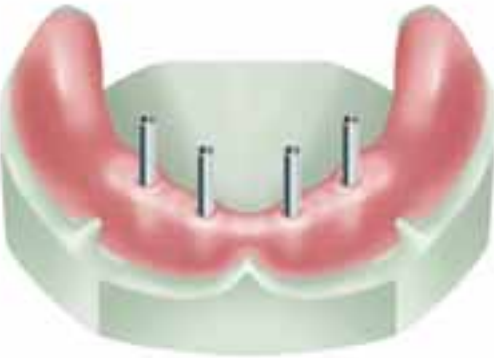

Fabricating a stabilized baseplate/occlusal rim

After the patient try-in, use the Hex Tool to replace the coping fixation screws with the longer Tapered Abutment Waxing Screws [SCWS]. Position a sheet of light-curing baseplate material over the tops of the assembled waxing screws and framework pattern. Gently press the modified sheet onto the working cast and allow the screws to penetrate the material. Form the material around the framework and to the contours of the edentulous arch to fabricate a stabilized baseplate.

Create a wax occlusal registration rim on the stabilized baseplate. Send the assembly to the dentist for interocclusal records.



Making an interocclusal record

Remove the Healing Caps [TATHC] from the abutments in the patient's mouth with the Hex Tool. Attach the baseplate and occlusal rim assembly to the abutments with the fixation screws and gently finger-tighten with the Hex Tool.

Contour the wax occlusal rim and mark the midline and smile line. Make a bite registration at the vertical dimension of occlusion. Remove the baseplate and bite registration from the patient's mouth and reassemble it on the working cast with the fixation screws. Reattach the Healing Caps to the abutments. Select the prosthetic teeth and send the materials to the laboratory for fabrication of a stabilized denture wax try-in.



Fabricating a stabilized denture wax try-in

Mount the working and opposing-arch casts on an articulator.

Set up the denture teeth on the stabilized baseplate. At this point, access to some of the copings will be covered up with denture teeth. Do not create access holes through the denture teeth. Two copings lingual to the anterior teeth will sufficiently stabilize the wax-up for patient try-in. Send the stabilized denture wax-up to the dentist for a patient try-in.



Patient try-in

Remove the Healing Caps from the abutments in the patient's mouth with the Hex Tool. Torque the abutments to 30 Ncm with a calibrated torque wrench. Place the try-in onto the abutments. Attach the fixation screws through the access holes in the wax-up and gently finger-tighten (note: some of the copings will be covered by the denture teeth). Make necessary adjustments and obtain patient approval. Remove the denture wax try-in from the patient's mouth and replace the Healing Caps on the abutments. Use the Hex Tool to secure the stabilized baseplate wax-up on the abutment replicas in the working cast with the fixation screws, and return it to the laboratory for fabrication of the metal framework.



Fabricating the framework pattern

Fabricate a silicone or plaster labial/occlusal matrix to record tooth position and the labial borders of the prosthesis relative to the working cast.

An alternate procedure for immediate framework fabrication would be to attach Bar Gold Copings [TGC3 or TGC5] to the replicas. Splint the copings with Gold Bars [HGB or DGB] using an autopolymerizing acrylic. Invest, solder and finish the framework via standard procedures (discussed in the **Immediate Bar Fabrication** Section page 96).



Fabricating the framework pattern

Remove the teeth from the denture wax try-in, place them back into their respective locations in the matrix and lute them into position with sticky wax. Retrieve the gold copings from the baseplate and retain them on the abutment replicas with the fixation screws. Press the Plastic Burnout Sheaths [OPS] onto the copings. Place the matrix with the attached teeth back onto the working cast to guide shortening of the Plastic Sheaths and design of the framework. Section the Plastic Sheaths with a cutting disk to provide adequate clearance for the teeth suspended in the matrix. Instead of using the Plastic Sheaths and fixation screws, the framework pattern can be waxed directly to the copings and around the Waxing Screws [SCWS].

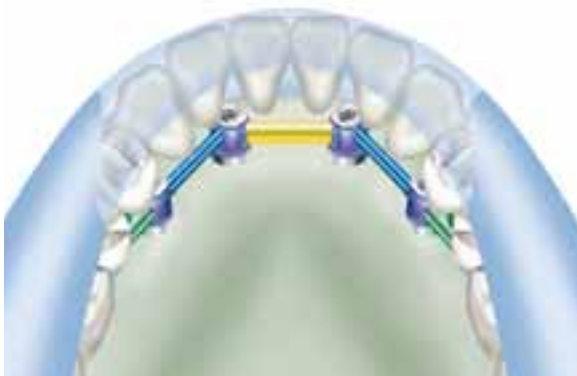

Fabricating the framework pattern

Incorporate the Gold/Plastic Combination [ACTGC] into a bar overdenture design using the preformed patterns from the Bar System [BS1]. Use the mandril from the Cap Attachment Instruments [CAI] in a surveyor to incorporate castable ball patterns from the Cap Attachment System [CAS] into the distal ends of the bar pattern, avoiding excessive cantilevers.

Use the teeth suspended in the matrix as a guide to provide adequate clearance for the attachments, teeth and the denture base thickness. The ball patterns are the same 2.5mm diameter as the machined titanium Ball Abutments and accept the standard Cap Attachments [CA].

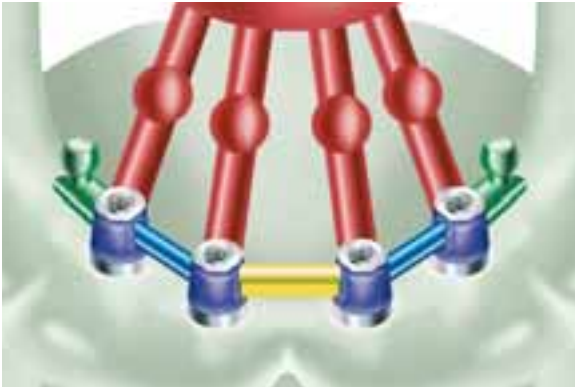

Spruing the framework pattern

Sprue the bar pattern with 10-gauge sprue wax with reservoirs. Invest the framework pattern with a high-heat, phosphate-bonded investment material following the manufacturer's instructions. Do not use a debubbler when investing the gold or plastic components. A two-stage burnout is recommended when using any type of acrylic burnout resin or large volume of wax. The burnout temperature should not exceed 1500°F (815°C), with a hold time of no longer than 1 hour. Cast the framework in a high noble or noble alloy exhibiting a high tensile strength. The casting temperature of the alloy must not exceed 2350°F (1288°C). After casting, the ring should be allowed to bench-cool. Do not quench.



Divesting and finishing the metal framework

To ensure that the fitting surface of the incorporated copings are not damaged, divest the casting, blast it with glass bead while protecting the coping interface, then clean the casting in an ultrasonic unit. Refine the screw access holes within the casting by rotating the Reamer [PR] for Tapered Abutment Copings by hand. Confirm that a passive fit has been achieved. Send the assembly to the dentist for try-in of the metal framework to verify the passive fit.



Patient try-in

Remove the Healing Caps from the abutments in the patient's mouth with the 1.25mmD Hex Tool. Retighten the abutments to 30 Ncm with a calibrated torque wrench. Seat the metal framework on the abutments. Beginning with one of the distal abutments, thread in the fixation screw and finger-tighten with the Hex Tool. If the framework lifts off the other abutments when the screw is tightened, the framework is not fitting passively. Determine where the framework should be sectioned and mark the location on the framework with a felt-tipped pen. Remove the framework and replace the Healing Caps. If a passive fit was achieved, attach the remaining screws and tighten to 20 Ncm with a calibrated torque wrench.



Correcting the framework for a passive fit

Remove the framework from the patient's mouth. Use a very thin separating disk and a high speed handpiece to section the framework diagonally to its occlusal surface for maximum strength after reconnection. Take care not to section in areas that have been designated for attachment placement. Incorrect sectioning of the framework may cause a weak solder joint, which will compromise the strength of the final prosthesis.

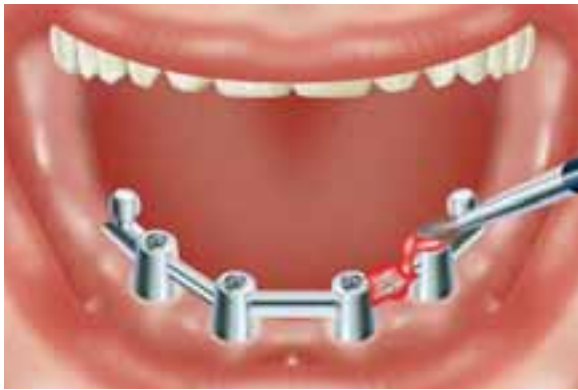

Correcting the framework for a passive fit

Remove the Healing Caps from the abutments with the Hex Tool. Tighten the abutments to 30 Ncm with a calibrated torque wrench. Attach the framework sections to the abutments with the fixation screws and tighten to 20 Ncm with the torque wrench. Apply fast-setting autopolymerizing resin to the sectioned areas. The resin will flow into the joint via capillary action. Apply additional resin to form a callous that encapsulates reinforcement across the sectioned area to strengthen the connection. After the resin has fully set, remove the reassembled framework. Do not reattach the luted framework to the working cast. Replace the Healing Caps on the patient's abutments and send the unattached, luted framework and working cast to the laboratory.



Correcting the framework for a passive fit

Follow standard laboratory procedures to invest, solder and finish the framework. Return the soldered framework and fixation screws to the dentist to verify that a passive fit has been achieved. Once a passive fit has been verified, the working cast must be adjusted to accommodate the soldered framework. Use a fissure bur to remove the misaligned abutment replicas from the working cast one at a time until the framework rests passively. Attach the removed replicas to the framework at the appropriate locations, then attach the framework to the remaining replicas in the working cast with the fixation screws. Soak the working cast in water, then carefully vibrate stone into the voids and around the retentive features of the replicas.



Fabricating a final stabilized denture wax try-in

Snap the yellow Cap Attachment Transfers [CAT] onto the distal ball components. Place the Metal Housings [CAH] onto the Cap Attachment Transfers. Align the Metal Housings for a common path of draw. Snap the Bar System [BS1] Processing Clip (green) onto the anterior bar segment. Block out undercuts then process a light-cure denture base that incorporates the attachments. Using the silicone index or matrix as a guide, lute the prosthetic teeth to the denture base with baseplate wax. To prevent fracture of the light-cure baseplate, place the yellow Cap Attachment Transfers on the Bar Ball components for the stabilized tooth try-in. Send the denture wax-up and metal framework to the dentist for try-in and final approval prior to final processing.



Patient try-in

Remove the Healing Caps from the abutments with the Hex Tool. Torque the abutments to 30 Ncm with the torque wrench and Hex Tool. Seat the metal framework onto the abutments, thread in the fixation screws with the Hex Tool and tighten to 20 Ncm with the torque wrench. Snap the yellow Cap Attachment Transfers onto the ball components of the metal framework. Place the denture wax try-in into the patient's mouth and allow the yellow transfers to insert into the Metal Housings in the baseplate. Verify that the anterior clip attaches to the bar. Evaluate and validate esthetics and phonetics. Place the set-up, metal framework and Cap Attachment Transfers back onto the working cast, and return them to the laboratory for final processing. Replace the Healing Caps onto the abutments in the patient's mouth.



Processing the final prosthesis

Process the denture with the appropriate attachments. In the anterior, utilize a green *Hader*® Processing Clip from the Clip Bar System [BS1] or similar attachment system. In the posterior, snap yellow Cap Attachment Transfers [CAT] onto the ball components. Place the Cap Attachment Housings [CAH] from the Cap Attachment System [CAS] onto the transfers. Align the Metal Housings for a common path of draw and then block out the undercuts beneath the metal housings with appropriate block-out material. Process the denture according to conventional laboratory procedures. If the *Hader* Clip is used, remove the green Processing Clip and use the *Hader* Clip Insertion Tool to insert the final yellow *Hader* Clip after the denture is processed.

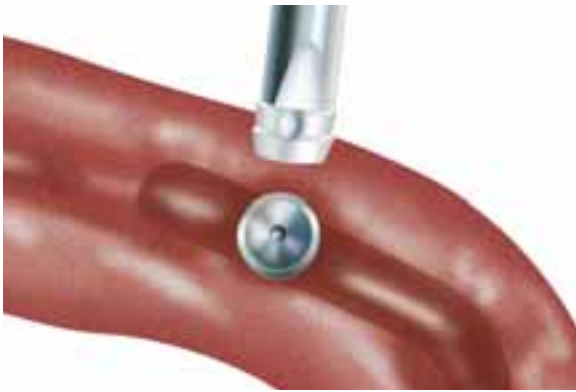

Processing the Cap Attachments

When the processed denture returns from the laboratory, remove the Healing Caps from the abutments in the patient's mouth with the Hex Tool. Tighten the abutments to 30 Ncm with a calibrated torque wrench. Seat the metal framework on the abutments, thread in the fixation screws with the Hex Tool and tighten to 20 Ncm with a calibrated torque wrench.

Place one Nylon Liner [CAN] from the Cap Attachment System [CAS] onto the end of the Insertion Tool from the Cap Attachment Instruments [CAI]. Press the Nylon Liner into one of the Metal Housings in the denture base.



Processing the Cap Attachments

Check the retention of the liner by snapping the denture on and off the Ball Bar in the patient's mouth. If necessary, decrease the retention of the Nylon Liner by inserting the Reaming Tool from the Cap Attachment Instruments [CAI] into the Nylon Liner and rotating in a clockwise direction to reduce the retention of the liner's walls. When adequate retention has been achieved, process the second liner in the same manner. Process only one Nylon Liner at a time.



Seating the final prosthesis

Insert the finished prosthesis into the patient's mouth and snap the incorporated attachments onto the Ball Bar. Make final adjustments to the occlusion. Instruct the patient in the use and care of the prosthesis, and provide oral hygiene instructions. Caution the patient not to use bleach on the prosthesis, which can damage the Cap Attachment Nylon Liners, and to insert/remove the overdenture by using vertical forces instead of twisting or lateral forces. Proper care will prolong the use of the Nylon Liners. If the Nylon Liners lose retention, they can be easily replaced at a recall appointment. For patients who require stronger Cap Attachment retention, a gray Cap Attachment Liner [CAN-G] with greater retention is also available.



Restorative Manual

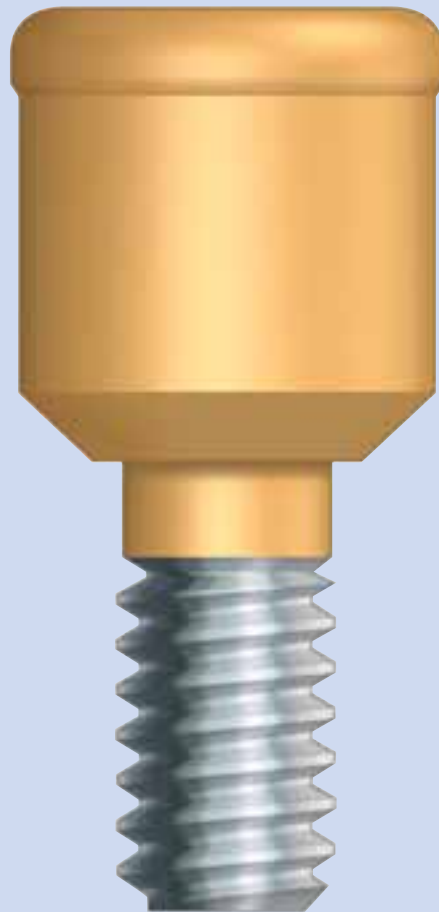

Locator Overdenture Attachment System

Restorative options with Locator Overdenture Attachments

Locator Overdenture Attachments are designed for retention of implant- or tissue-supported overdentures and partial dentures. The self-locating design of the *Locator* Attachment System helps guide the attachment into place on the abutment, allowing the patient to position their denture into place easily.

The Nylon *Locator* Male pivots within the Metal Housing for a resilient connection. The retentive Nylon Liner remains completely in contact with the abutment socket while its titanium denture cap has a full range of rotational movement.

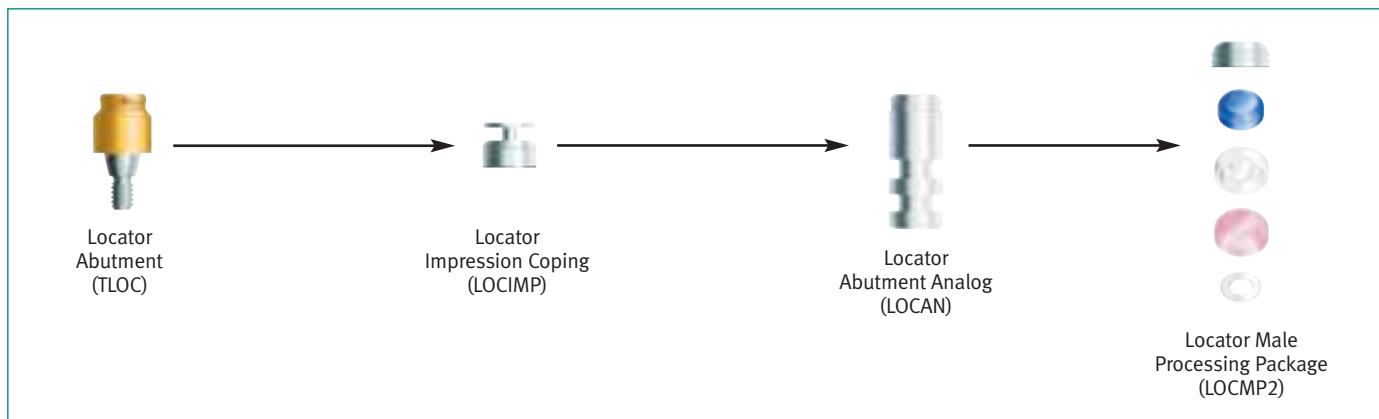

Figure 1 - The self-aligning design of the Locator Attachment System helps guide the attachment into place on the abutment.

The low vertical height of *Locator* Overdenture Attachments makes it an effective treatment option for a wide variety of patients, and the abutments are available in a variety of cuff heights to accommodate varying tissue depths. The cuff height is chosen by measuring tissue depth and ordering the cuff height that equals the tissue measurement or is the next closest higher size. Ordering the abutment by exact tissue height will position the working attachment above the surrounding tissue appropriately.

Impression Copings are available for standard impression-taking, and the Processing Cap is used for a relined impression. The Male Processing Package (LOCMP2) includes two full sets of Processing Caps with black Processing Males, Block-Out Spacers and clear, pink and blue Replacement Male Liners.

Figure 2 - Locator Overdenture Restoration Flowchart.



A full selection of Nylon Liners allow flexibility and varying levels of retention. For cases within 10° parallel per abutment, three levels of retention are available: 1.5 pounds (blue), 3 pounds (pink) and 5 pounds (clear). Special Nylon Males accommodate up to 40° of divergence (20° for one implant) with two levels of retention: 4 pounds (green) and 1.5 pounds (red). *Locator* Attachments are not appropriate where a totally rigid connection is required and should not be used on a single implant with divergence of greater than 20°.

Figure 3 - Locator Replacement Males.



Figure 4 - The Locator Core Tool (LOCCT2) consists of three pieces used throughout the restorative process:

- 1) Male Component Removal Tool
- 2) Male Component Seating Tool
- 3) Locator Abutment Driver

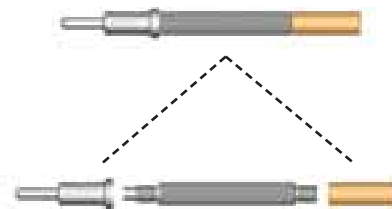



Preparing the implant site for Locator Attachments

Remove the healing components from the implants with the 1.25mmD Hex Tool. Ensure all bone and soft tissue are removed from the superior aspect of the implant for complete seating of the *Locator* Attachment.

3.5mmD Platform



Selecting the Locator Attachments

Choose a cuff length based on the tissue depth. Determine the tissue depth by measuring from the coronal rim of the implant body to the crest of the soft tissue in three or four areas. Choose the corresponding abutment cuff height that equals the tissue measurement or is the next closest higher size. The exact tissue cuff height of the *Locator* Abutment will position the proper amount of working attachment above the surrounding gingival level.



Seating the Locator Attachments

Insert the *Locator* Abutment into the implant and rotate into position using the Abutment Driver.

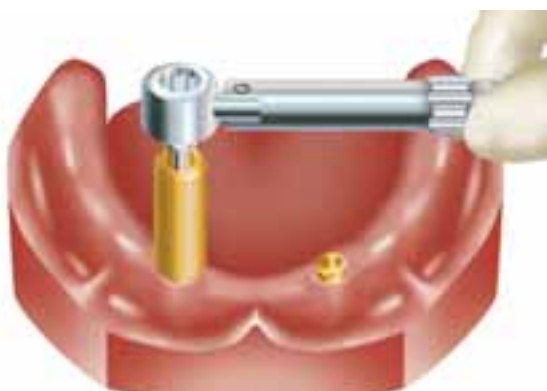

Tightening the Locator Attachments

Insert a 1.25mmD Hex Tool into the back end of the Abutment Driver. Apply a minimum of 20 Ncm of torque with a calibrated Torque Wrench. As an alternative, use the *Locator* Torque Wrench Insert Driver with the Torque Wrench for tightening of the abutment.



Determining divergence and selecting Replacement Males

Attach the Parallel Posts to the abutments to determine the degree of divergence. If the divergence is less than 10° use one of the *Locator* Replacement Males (clear=5lbs., pink=3 lbs. or blue=1.5 lbs.). If the angle is between 10° and 20° use an Extended Range Replacement Male (green=4 lbs. or red=1.5 lbs.) which can accommodate a divergent implant up to 20° (40° between implants).

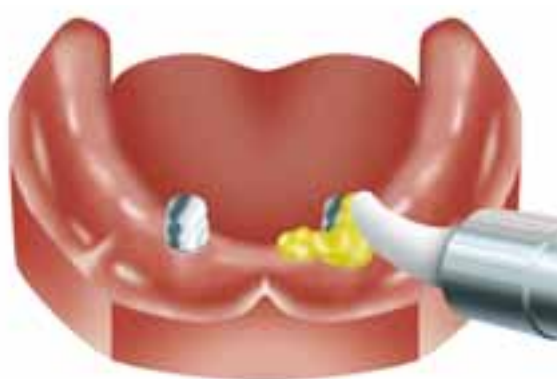

The standard transfer procedure

Place the *Locator* Impression Coping with black Processing Male onto each *Locator* Attachment. Inject light-body impression material around the transfers in a "wash" technique and then record a full-arch impression with standard body material. The *Locator* Impression Coping is retained in the impression material.



Completing the standard transfer procedure

Insert the Abutment Analogs into the Impression Copings located within the impression material.

Standard Impression Technique
Using Impression Coping



Optional Reline
Technique Using
Processing Cap



Abutment
Analog

Completing an alternative reline impression

An optional technique is to use the patient's prosthesis in combination with the Processing Cap with black Processing Male for a reline impression. When the denture is removed, the Processing Cap Male will remain in the denture. Snap the Analog into the Processing Male, making sure it is fully seated.



Processing the denture

Pour the working cast. The *Locator* Abutment Analog replicates the position of the *Locator* Attachment on the model. Place the white Block-Out Spacer over the head of the *Locator* Abutment Analog. The space created will allow the full resilient function of the pivoting metal denture cap over the *Locator* Male. Attach the Processing Cap with black Processing Male and ensure it is fully seated. The black Processing Male will maintain the overdenture in the upper limit of its vertical resiliency during the processing procedure. Process the denture following standard procedures. Discard the white spacer. Before changing to the final male, polish the denture base.

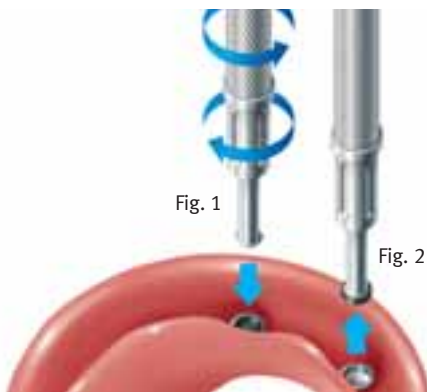

Removing the black Processing Male

Loosen the *Locator* Male Removal Tool tip a full two turns counter-clockwise and insert the tip into the cap/male assembly and push straight in (Fig. 1). The sharp edge of the tip will grab the Nylon Male and allow you to pull it out. Tighten the tip clockwise back into the Core Tool to release the liner (Fig. 2).



Seating the Replacement Male

Use the *Locator* Male Seating Tool to firmly push the *Locator* Replacement Male into the empty metal cap located within the denture. The male component must sit flush with the rim of the metal cap.



Delivering the final prosthesis

The *Locator* Attachments should be retightened with a minimum of 20 Ncm of torque. Instruct the patient in the path of insertion. Have the patient insert and remove the appliance several times. The self-locating design helps guide the attachment into place on the abutments.



Restorative Manual



Ball Abutment System

Ball Abutments are used in attachment-retained, tissue-supported restorations where the patient is fully edentulous in the arch to be restored. The extra-coronal type of attachment mechanism consists of a one-piece abutment with a superior ball projection secured to the implant. A Metal Housing [CAH] and retentive Nylon Liner [CAN] mechanically retained within the Metal Housing, collectively referred to as the Cap Attachment [CA], is fixed within the patient's denture. The inner receptacle of the Nylon Liner acts as the 360-degree universal rotational connection between the denture and the abutment/implant assembly and allows for only slight compressive vertical movement. These abutments can be processed into the denture either in a chairside pick-up technique or a laboratory technique. Both techniques will be discussed in this section.

This type of restoration requires sufficient depth of the posterior vestibule to protect the abutment/implant assembly from excessive lateral/horizontal force during mastication (Fig 1a-c). It is recommended to use implants with a length in excess of 12mm and abutment heights should be kept to a minimum to maintain an acceptable implant/abutment height ratio. Therefore single-arch fully edentulous patients with excessive resorption of the edentulous ridge might not be candidates for a restoration inclusive of this type of abutment system.

In most cases the restoration is done utilizing two implants with corresponding Ball Abutments placed in the canine area, creating a fulcrum around which the attached denture will rotate (Fig. 1d). Absolute parallelism is not a prerequisite for success as the rotational aspect of the Cap Attachment on the ball component allows for adjustment of up to 28 degrees of relative divergence between implants. It should be noted that the long-term stability and maintenance of the retentive connection is reliant on three-dimensional alignment of the abutments and Cap Attachments (as shown below, Fig. 1e-1f) for increased longevity and success:

- 1) The implants should be placed anterior/posteriorly so that the fulcrum line through the center of the components is parallel to the mandibular hinge axis (Fig. 1e).
- 2) The implants should be placed vertically so that the tops of the metal housings are parallel to the occlusal plane of the patient's denture and corresponding opposing arch (Fig. 1f).
- 3) The implants should be parallel to each other along their long axis and perpendicular to the plane of occlusion to be in optimum position (Fig. 1g).

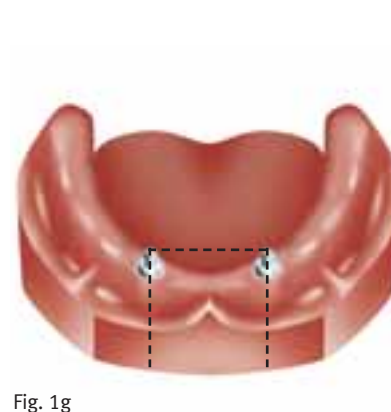
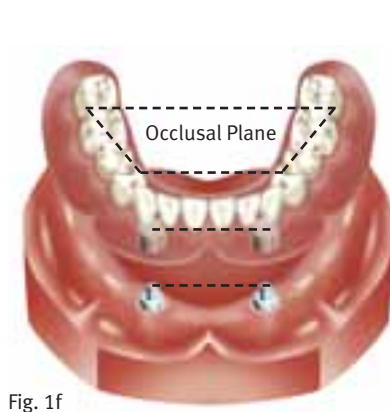
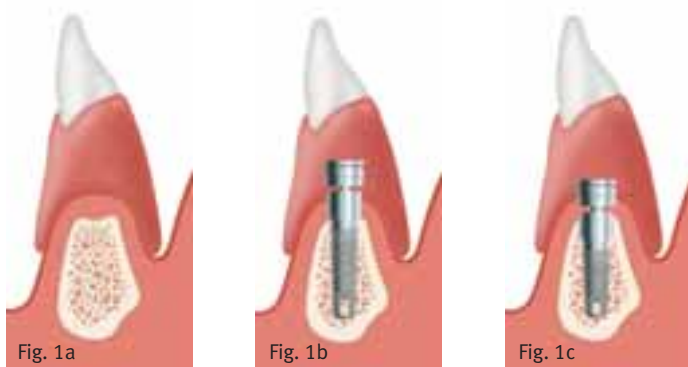

Ball Abutment for Tapered Screw-Vent, Screw-Vent and AdVent Implant Systems

Ball Abutments are manufactured from titanium alloy and come packaged with the stainless steel Cap Attachment Housing [CAH] and Cap Attachment Nylon Liner [CAN]. The abutments for the *Tapered* and *Straight Screw-Vent* 3.5 and 4.5mmD Platform Implants are available in three collar heights (2mmL, 4mmL and 6mmL). The 5.7mmD platform *Tapered Screw-Vent* and *AdVent* Implant abutments have collar heights of 2mm and 4mm only. The 4.5mmD platform *AdVent* Implant System, however, has only one collar height (1mmL) which can be utilized with or without the *AdVent Extender* [AVE] to create variable heights, depending on the depth of implant placement and surrounding soft tissue.

The Ball Abutment collar is regularly placed 1mm supragingival and has a coronal diameter of 4.5mm, while the ball component itself is 2.5mmD. When assembled, the vertical height of the Cap Attachment [CA] above the coronal aspect of the Ball Abutment collar is 4.28mm and its diameter is 5.00mm. Care should be taken to ensure sufficient denture acrylic surrounds the housing to prevent it from perforating the denture during function.

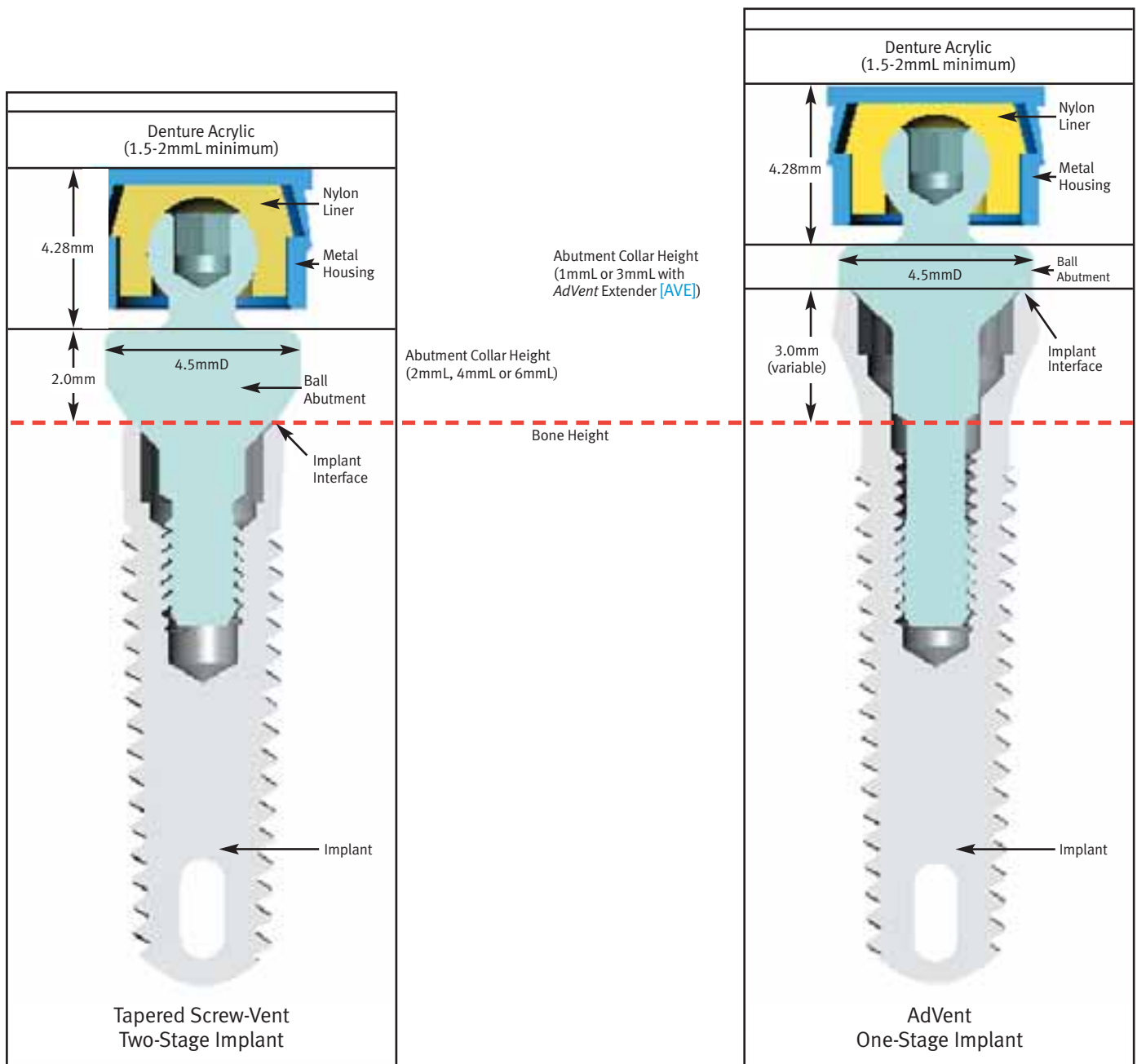

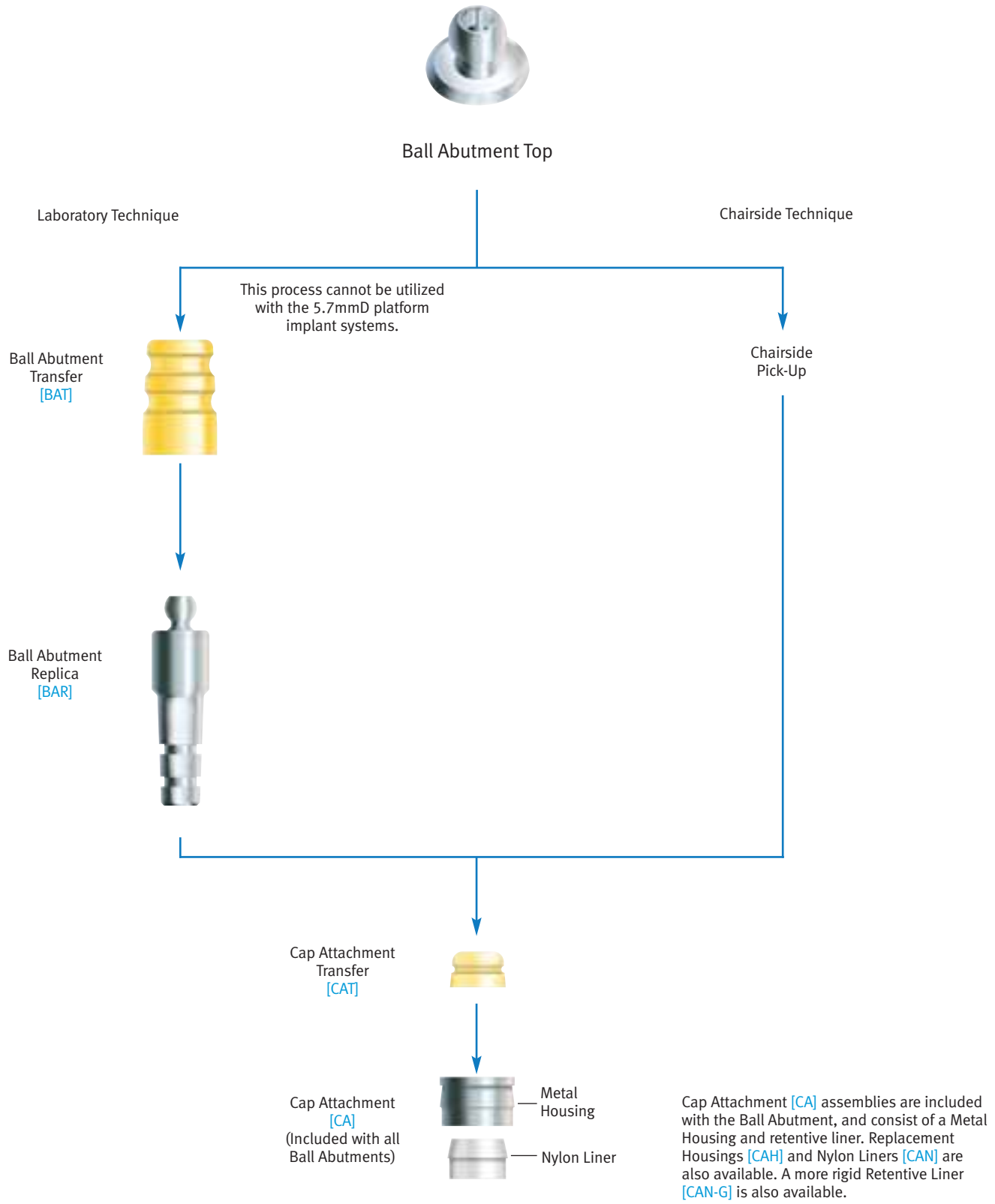



Fabricating a custom tray

Prior to attaching the abutments, make a full-arch, alginate impression of the Healing Collars and edentulous areas. Send the impression to the laboratory for fabrication of a working cast and an impression tray with a spacer to accommodate the Ball Abutment Transfers. Fabricate the custom tray with light-cured or autopolymerizing tray material. The patient's existing, modified overdenture can continue to be worn during the laboratory phase. Alternatively, select a stock tray to provide access for the transfers, and mold a border with greenstick compound material.



Attaching the ball components

Recall the patient when the custom tray is ready. Remove the Healing Collars or Surgical Cover Screws with the 1.25mmD Hex Tool. Select Ball Abutment components according to the implant type and transmucosal height requirements. Place the selected Ball Abutments into the implants and tighten with to 30 Ncm with a calibrated torque wrench.



Seating the transfers

Press the Ball Abutment Transfers [BAT] for all 4.5mmD collar components onto the Ball Abutments. This step cannot be done on the 5.7mmD platform implant systems.

The transfer will engage the outer portion of the abutment beneath the ball for maximum stabilization. An elastomeric impression material is recommended, such as vinyl polysiloxane. Inject light-body impression material around the Ball Abutments and fill the impression tray with heavier-body impression material. Place the loaded tray into the patient's mouth and allow the impression material to set according to the manufacturer's recommendations. Remove the impression from the mouth.



Completing the transfer procedure

Remove the Ball Abutment Transfers from the Ball Abutments, press them onto the Ball Abutment Replicas [BAR], and insert them back into the impression holes. A double-click indicates that the transfers are fully seated. Make an opposing-arch impression. Send all the materials to the laboratory for fabrication of a stabilized baseplate with occlusal registration rim.



Fabricating a stabilized baseplate and bite rim

Pour the impression in die stone. Remove the tray from the cast and the Ball Abutment Transfers from the Ball Abutment Replicas now incorporated within the working cast.

Press-fit the yellow Cap Attachment Transfers [CAT] onto the Ball Abutment Replicas in the working cast. Place the Cap Attachment Housings [CAH] (included with the Ball Abutments) onto the Cap Attachment Transfers.



Fabricating a stabilized baseplate and bite rim

Rotate the assembled housings and transfers up to 28° to create relative parallelism for a common path of draw. Block out the undercuts beneath the housing assemblies with an appropriate silicone or wax material.



Incorporating the housings into the baseplate

Place gel viscosity light-cure resin material on the Metal Housings and cure. Incorporate the housings into a stabilized baseplate made from light-cured baseplate resin. Create a wax occlusion registration rim on the stabilized baseplate. Place the assembly on the working cast and send it to the dentist for fabrication of a stabilized bite registration.



Making a stabilized bite registration

Snap the yellow Cap Attachment Transfers onto the Ball Abutments in the patient's mouth. Place the stabilized baseplate and occlusal registration rim into the patient's mouth and allow the transfers to insert into the Metal Housings in the baseplate. Make a bite registration with the stabilized baseplate and occlusion rim. Send the assembly to the laboratory for fabrication of a stabilized denture wax try-in.



Making a stabilized denture wax try-in

After the laboratory fabricates a stabilized denture wax-up, recall the patient for try-in. Snap the yellow Cap Attachment Transfers onto the Ball Abutments in the patient's mouth. Place the denture wax try-in into the patient's mouth and allow the transfers to insert into the Metal Housings in the baseplate. Evaluate esthetics and phonetics, and verify that the wax-up fits passively. If changes in tooth position are prescribed, schedule additional try-in appointments until acceptable tooth arrangement is verified and approved by dentist and the patient. Place the approved stabilized denture wax try-in on the working cast with the Cap Attachment Transfers and send it to the laboratory for final processing.

Cap Attachment Instruments [CAI]



Nylon Liner Insertion Tool



Nylon Liner Reaming Tool



Mandril for Castable Ball Pattern

Cap Attachment instruments

- A) Nylon Liner Insertion Tool: Used to carry and assist in the insertion of the Nylon Liner into the Metal Housing.
- B) Reaming Tool: When the Nylon Liner is too retentive for the respective patient, the Reaming Tool is inserted into the liner and rotated in a clockwise direction. This action reduces the amount of retention between the Ball Component and the Cap Attachment by reducing the dimension of the liner's inner walls. Care should be taken to do this in small increments so as not to eliminate the required retention levels of the Nylon Liner.
- C) Paralleling Mandril: Used by the technician in combination with a surveyor to align the castable ball patterns in the correct position when fabricating a ball bar overdenture.



Processing the final prosthesis

When the processed denture returns from the laboratory, retighten the Ball Abutments to 30 Ncm with a calibrated torque wrench. Place one Nylon Liner [CAN] from the Cap Attachments [CA] onto the end of the insertion tool. Use the Insertion Tool to press the Nylon Liner into one of the metal housings in the denture base. Check the retention of the liner by snapping the denture on and off the ball component in the patient's mouth. If necessary, use the Reaming Tool to decrease the retention of the Nylon Liner. When adequate retention has been achieved, process the second Nylon Liner in the same manner. Insert and adjust only one Nylon Liner at a time.



Delivering the final prosthesis

Insert the finished prosthesis into the patient's mouth and snap the incorporated Cap Attachments onto the Ball Abutments. Make final adjustments to the occlusion. Instruct the patient in the use and care of the prosthesis, and provide oral hygiene instructions. Caution the patient not to use bleach on the prosthesis, which can damage the nylon Cap Attachment liners. To prolong the use of the Nylon Liners, instruct the patient to insert and remove the overdenture by lifting the prosthesis vertically instead of laterally or by twisting. If the Nylon Liners lose retention, they can be easily replaced at a recall appointment. For patients who require stronger Cap Attachment retention, gray Nylon Liners [CAN-G] with a more rigid retention are also available.



Attaching the ball components

Recall the patient when the custom tray is ready. Remove the Healing Collars or Surgical Cover Screws with the 1.25mmD Hex Tool. Select Ball Abutment Components according to the implant type and transmucosal height requirements. Place the selected ball components into the implants and tighten to 30 Ncm with a calibrated torque wrench.



Preparing the housings for pick-up

Snap the yellow Cap Attachment Transfers [CAT] onto the Ball Abutments. Place the Cap Attachment Stainless Steel Housings [CAH] over the transfers.



Preparing the housings for pick-up

Rotate the assembled Cap Attachment Transfers [CAT] and Metal Housings [CAH] on the Ball Abutments up to 28° to create relative parallelism for a common path of draw. Try and ensure that the components are aligned taking into consideration the occlusal plane of the denture; this will help with the smooth rotation of the denture around the Ball Abutment.



Preparing the denture for pick-up

Seat the denture into the patient's mouth to determine the locations of the Metal Housings relative to the tissue-bearing surface of the prosthesis. Remove the denture from the patient's mouth and mark the locations of the assembled housings on the bottom of the prosthesis. Relieve the areas over the housings with an acrylic bur until the denture can be fully seated in the patient's mouth without contacting the Metal Housings.

Small relief holes can be drilled through the top of the recess to allow excess acrylic to exude through.

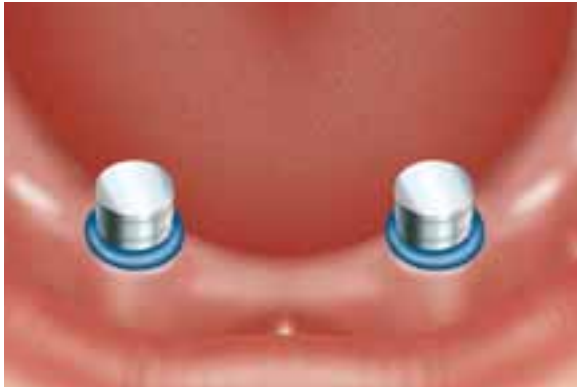

Preparing the housings for pick-up

Block out the undercuts beneath the housing assemblies with an appropriate silicone or wax material, taking care not to change the orientation of the housings on the Ball Abutment.



Processing the housings into the denture base

Autopolymerizing acrylic is recommended for the pick-up. It flows better than a light-cured resin and engages the undercuts on the outside of the Metal Housings [CAH] more efficiently. Place a small amount of autopolymerizing acrylic into the dry, relieved areas within the denture base. Also place a small amount of acrylic directly on the tops of the housings. Place the denture over the housings in the mouth and instruct the patient to bite lightly in centric occlusion. Remove the denture after the acrylic sets. Fill in any voids remaining around the processed housings with additional autopolymerizing acrylic.



Processing the Nylon Liners into the denture base

Remove the yellow Cap Attachment Transfers from the Ball Abutments in the patient's mouth. Place one Nylon Liner [CAN] from the Cap Attachments [CA] onto the end of the insertion tool from the Cap Attachment Instruments [CAI]. Press a Nylon Liner into the Metal Housing in the denture base. Check the retention of the liner by snapping the denture on and off the ball component in the patient's mouth. If necessary, decrease the retention of the liner by inserting the Reaming Tool from the Cap Attachment Instruments into the liner and turning it clockwise to reduce the retention of the liner's inner walls. When adequate retention has been achieved, process the second liner in the same manner. Insert and adjust only one Nylon Liner at a time.



Delivering the final prosthesis

Insert the finished prosthesis into the patient's mouth and snap the incorporated Cap Attachments onto the Ball Abutments. Make final adjustments to the occlusion. Instruct the patient in the use and care of the prosthesis, and provide oral hygiene instructions. Caution the patient not to use bleach on the prosthesis, which can damage the Cap Attachment Nylon Liners. To prolong the use of the Nylon Liners, instruct the patient to insert and remove the overdenture by lifting the prosthesis vertically instead of laterally or by twisting. If the Nylon Liners lose retention, they can be easily replaced at a recall appointment. For patients who require stronger Cap Attachment retention, gray Nylon Liners [CAN-G] with more retention are also available.



Restorative Manual



Immediate Bar Fabrication

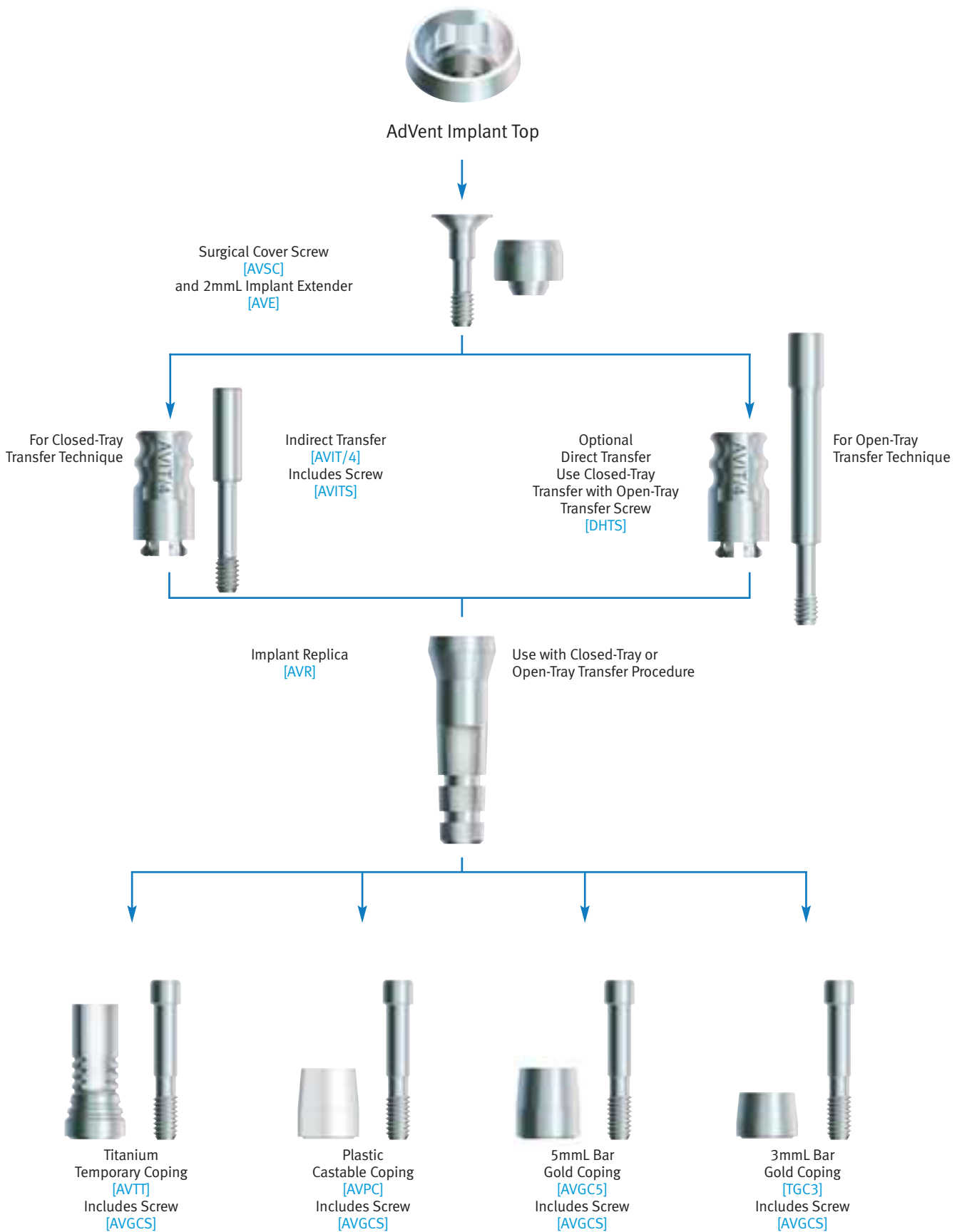



Attaching the transfers

After threaded implant placement, attach Transfers [AVIT/4] with 1.25mmD Hex Tool.

For implants with a Fixture Mount/Transfer already attached, proceed to next step.

Optional: Long Impression Screws [DHTS] may be used for open-tray impression technique.



Making the impression

Block out the top of the transfer and any exposed sutures. Place light-body impression material around each transfer and record a full-arch impression with standard body material. Remove the impression after it fully sets.

A silicone putty bite registration and opposing-arch impression can also be made at this time. This optional procedure will assist the technician in aligning the bar segments parallel to the plane of occlusion.

Unscrew the transfers from implants and forward with the impression for fabrication of a working cast.

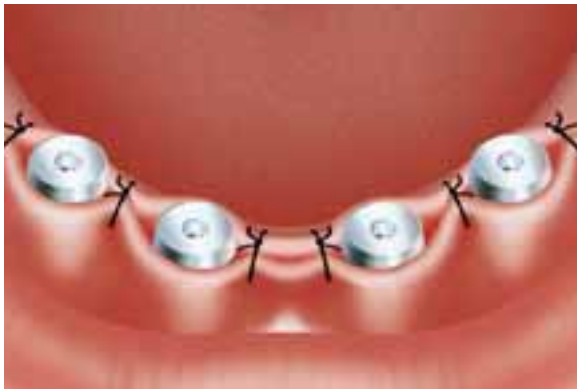

Attaching the healing components

Attach the Surgical Cover Screws [AVSC] using the 1.25mmD Hex Tool. Seat the *AdVent* Extenders [AVE] onto the implants prior to threading the screws into the implants if an increase in transmucosal height is required.



Fabricating the working cast

Connect the transfer to a corresponding Replica [AVR] and insert the replica/transfer assembly into the impression hole. A double-click indicates that the transfers are fully seated. Pour the impression in die stone to create the working cast. If desired, use soft tissue material to represent the gingival tissues.

Remove the tray from the cast. Unthread the Transfer Screw [AVITS] with the Hex Tool prior to removing the transfer bodies from the cast.



Attaching the bar components

Attach Bar Gold Copings to replicas with a 1.25mmD Hex Tool. Use variable height Bar Gold Copings [AVGC3 - 3mmL or AVGC5 - 5mmL] to adjust the height of the final bar depending on the heights of the implants relative to the surrounding tissue.

Alternative technique involves use of screw-retained abutments with gold or plastic copings for cast bar fabrication shown in section on **Tapered Abutment System** on page 68.

Fig. A



Fig. B



Fig. C



Fig. D



Fig. E



Selecting gold bar design

- 1) Dolder Gold Bar [DGB] is an oval-shaped bar 2.3mm in height and an adjustable 50mm in length (Fig. A). Used in conjunction with a matching metal sleeve (Fig. B) and processing spacer (Fig. C) it is designed to allow rotational and vertical movement.
- 2) Hader Gold Bar [HGB] is a round-shaped bar 1.8mm in diameter and an adjustable 50mm in length (Fig. D). Used in conjunction with a matching yellow plastic rider (*Hader Clip*) and green Processing Clip (Fig. E) it is designed to allow rotational movement.

The melting range of the prefabricated bars is 1670-1823°F or 910-995°C.



Measuring the gold bar

Measure gold bar segments to fit between the Bar Gold Copings. Design the segments to run parallel to the plane of occlusion and to allow sufficient space between the bar and soft tissue to ensure easy access for cleansing.

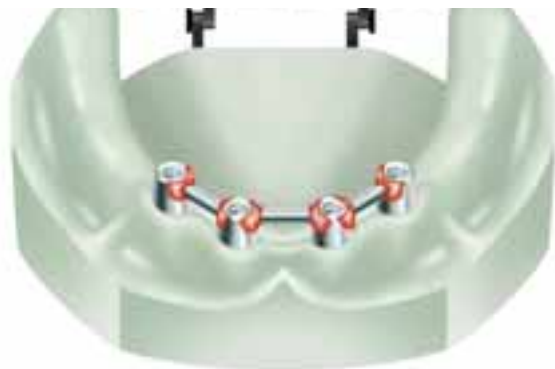

Luting the gold bar

Cut and shape gold bar patterns to fit between the Bar Gold Copings. Roughen the surface of the coping to enhance attachment of the luting material. Lute the bar segments in place with an autopolymerizing resin parallel to the plane of occlusion.

Remove framework from working cast and prepare for placement in soldering investment material.

Proceed to common procedures for prosthesis fabrication on page 101



Removing the healing components

Remove sutures after the required soft tissue healing period. Remove the Surgical Cover Screw [AVSC] and Extender [AVE] if placed, prior to restorative procedures.



Attaching the bar components

Seat the Bar Gold Coping on the implant. Use a 1.25mmD Hex Tool to thread the Coping Screw [AVGCS] into the implant and tighten to 20 Ncm with a calibrated torque wrench.

Note: This screw which connects directly to the implant should ultimately be tightened to 30 Ncm once a satisfactory period for hard tissue healing has occurred.

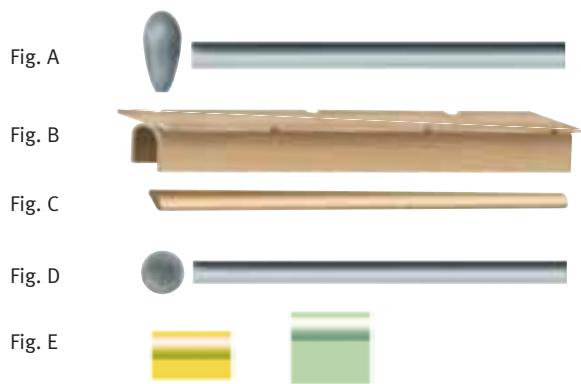

Selecting gold bar design

- 1) Dolder Gold Bar [DGB] is an oval-shaped bar 2.3mm in height and an adjustable 50mm in length (Fig. A). Used in conjunction with a matching metal sleeve (Fig. B) and processing spacer (Fig. C) it is designed to allow rotational and vertical movement.
- 2) Hader Gold Bar [HGB] is a round-shaped bar 1.8mm in diameter and an adjustable 50mm in length (Fig. D). Used in conjunction with a matching yellow plastic rider (Hader Clip) and green Processing Clip (Fig. E) it is designed to allow rotational movement.

The melting range of the prefabricated bars is 1670-1823°F or 910-995°C.

Measuring the gold bar

Measure gold bar segments to fit between the Bar Gold Copings. Design the segments to run parallel to the plane of occlusion as well as allow sufficient space between the bar and soft tissue to ensure easy access for cleansing.





Placing the bar sections

Roughen the surface of the coping to enhance attachment of the luting material. Cut and shape gold bar patterns to fit between the Bar Gold Copings. The sections should have an intimate fit so as to reduce the amount of solder space between the adjacent components. The connection between the bar section and coping should be on a slight taper to increase the surface area of contact between the two components, improving the strength of the connection. The tapering of the coronal circumference of the Bar Gold Copings is designed to assist in the planning of tapered connection between the components.



Luting the bar sections

Lute the bar segments [DGB or HGB] and Bar Gold Copings [AVGC3 or AVGC5] in place using autopolymerizing burnout resin or equivalent light-cure material of choice. Reinforce the joints by overbulking with additional resin. Note: Place bars in their correct three-dimensional orientation to ensure correct function of attachments. Loosen the Bar Gold Coping Screws with the Hex Tool and then remove. Carefully remove the bar pattern from the oral cavity. Replace the Surgical Cover Screw [AVSC] and Extender [AVE] if previously attached. The following step can either be performed in the dental office or sent to the dental laboratory.



Attaching the Implant Replicas

Insert the Coping Screw [AVGCS] through the top of the coping and gently thread it into the Implant Replica [AVR] with the Hex Tool. Hold the replica firmly while rotating the screw.



Making the stone index

Insert the bar/replica assembly into a soft mix of die stone to create an index of the position of the luted framework. This index will allow the technician to verify the fit of the framework after the solder process.

Realign the bar sections if necessary and lute them into position. Mold the burn out resin to conform to the slightly oversized shape of the final solder connection between the components.

Proceed to common procedures for prosthesis fabrication on page 101

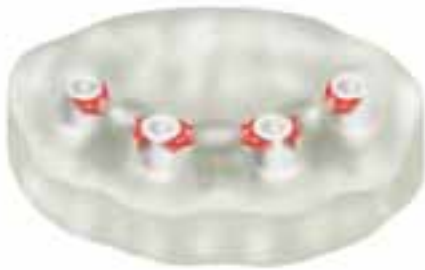

Preparing luted bar for soldering

Carefully remove the luted bar assembly from the stone die index or working cast, depending on which method was utilized to create the assembly.

Place the bar assembly into a slurry of silica-bonded soldering investment material, ensuring that all metal components are covered and held in position by the material. Remove excess investment material from around the joint to ensure easy access for flow of heat and solder. Place the set material into the burn out oven to eliminate the resin material.



Soldering of bar segments

Solder using the direct-oven or the open-flame technique, ensuring that the temperature to melt the low-fusing solder does not exceed 1544°F or 840°C.

After bench-cooling, the soldered bar is divested. Finish the soldered joints and lightly polish the bar following standard laboratory procedures. Take care not to alter the dimensions of the bar segments or the Bar Gold Coping interface.

An option to the above solder technique would be to join the components using laser welding. Temperatures must be regulated to accommodate for the melting range of the gold bars.



Attaching the soldered bar

Remove the Surgical Cover Screws with the Hex Tool. Remove Implant Extenders [AVE] if previously attached. The sterilized bar is seated on the implants in the patient's mouth.

To determine a passive fit on the implants, a distal gold cylinder incorporated within the bar was attached to its corresponding implant with an Abutment Screw [AVGCS]. Finger-tighten the screw with the 1.25mmD Hex Tool. Visually inspect to verify that no discernable gaps are present between the remaining gold cylinders and implants. If a gap is present between the bar and any of the other implants, section the bar appropriately, relute in position and send back to the laboratory for resoldering.



Creating void in the denture

The patient's existing or newly-created denture can be used. Create adequate clearance in the denture base to accommodate the bar and implants without contact when the denture is seated over them and placed into occlusion with the opposing dentition.

Techniques for processing the clips in the denture:

- 1) Laboratory: Make a reline impression of the bar attached to the implants, then send bar and denture to the laboratory for relining of the denture and processing of the clips on the working cast (described on following page).
- 2) Intraoral: Pick up the clips off the bar, following traditional prosthodontic techniques, ensuring sufficient block-out of the bar.



Making the impression

Block out undercuts beneath the bar with a material dissimilar to the impression material. Keep the block-out area to a minimum to ensure that the profile of the bar is transferred accurately to the final impression. The defined profile within the impression will assist the technician in retrofitting the bar with attached Implant Replicas [AVR] into the impression in its correct spatial position. Apply tray adhesive to the under surface of the prepared denture. Make a full-arch impression. Gently close into centric occlusion and simultaneously check that the vertical dimension of occlusion does not change. Remove the bar, attach healing components to the implants. Send impression and bar to laboratory for processing of denture.



Processing the denture

Pour the impression and attached bar and implant replicas in die stone. Trim then mount the working cast in a reline jig. Follow standard laboratory procedures for relining or rebasing and processing of bar/clip dentures.

Use a scalpel to produce a longitudinal slit in the green Processing Clip. Fold the sides of the clip on each other then remove. Use the *Hader Clip Seating Tool*, supplied with the Bar Kit [HGB], to insert the final yellow *Hader Clip* into the recess created by the Processing Clip.



Trimming the denture

The denture must be processed or trimmed to allow for free rotation of the denture around the yellow clip on the bar, which acts as the fulcrum for the denture. This free rotation will allow the surrounding soft tissue to assist in carrying load applied to the prosthesis during the healing process.

Return the processed denture and bar to the clinician for final delivery.



Delivering the final prosthesis

Sterilize the components prior to insertion in the patient's mouth.

Secure the bar in place with the Bar Gold Coping Screws and tighten to 20 Ncm with a calibrated torque wrench. Reseat the denture and make final adjustments. Note: This screw which connects directly to the implant should ultimately be tightened to 30 Ncm once a satisfactory period for hard tissue healing has occurred.

Instruct the patient in the use and care of the prosthesis, and provide oral hygiene instructions. Caution the patient not to use bleach on the prosthesis, which can damage the nylon clip.



Restorative Manual



Non-Engaging Gold Abutment System

Non-Engaging Gold Abutments are used to fabricate implant-level, custom restorations that provide reduced height for vertical occlusal clearance and/or implant angles. These abutment assemblies consist of a non-engaging gold base, an abutment screw and typically a castable press-fit Plastic Sheath.

The press-fit Plastic Sheath is modified and incorporated into the wax framework pattern. After investing, the wax and Plastic Sheath are burned out of the pattern following the lost wax process. When molten alloy is cast into the investment mold, the base component is incorporated into the casting and provides a machined interface that mates directly with the implant.

The finished casting can be used as the sub-structure for:

- 1) A screw-retained partial denture that receives a veneering material of choice.
- 2) An implant level multi-unit bar when vertical occlusal clearance does not allow for vertical stacking of the Tapered Abutment components.
- 3) An implant level multi-unit bar when bucco-lingual or mesial-distal angulation of implants and prosthesis profile does not allow for vertical stacking of the Tapered Abutment components.

The gold base is fabricated from a non-oxidizing alloy that promotes chemical adhesion of the cast alloy, but does not permit the adhesion of porcelain. Therefore, a porcelain bonding alloy must be added to all areas of the gold base where porcelain veneering is desired.

Screw-Retained Partial Denture



Bar Overdenture



Screw-Retained Partial Denture



Abutment for the Internal Hex Implant, 3.5mmD platform



"Cast-To"
Gold Abutment
[NEA3G]

Abutment for the Internal Hex Implant, 4.5mmD platform



"Cast-To"
Gold Abutment
[NEA4G]

Abutment for the AdVent Implant, 4.5mmD platform



Bar Gold
Coping
[AVGC3]

Note: These components are not available for the 5.7mmD platform.

Non-Engaging Gold Abutments for Tapered Screw-Vent, Screw-Vent and AdVent Implant Systems

Non-Engaging Gold Abutments [NEA3G and NEA4G] for *Tapered Screw-Vent* and *Screw-Vent* implants with a 3.5mmD and 4.5mmD platform, have a low profile that allows for a subgingival connection to the implant platform.

The abutments are packaged with a gold base, a 3.8mmD Plastic Castable Sheath [OPS] and an Abutment Screw [MHLAS] for [NEA3G and NEA4G]. The Abutment Screw [AVGCS] is for the standard platform (4.5mmD) *AdVent* Bar Gold Coping [AVGC3 or AVGC5].

Once all the restorative components are in place, the minimum vertical clearance between the implant interface and the opposing dentition is 3.75mmL and 3.5mmL, respectively (as shown below).

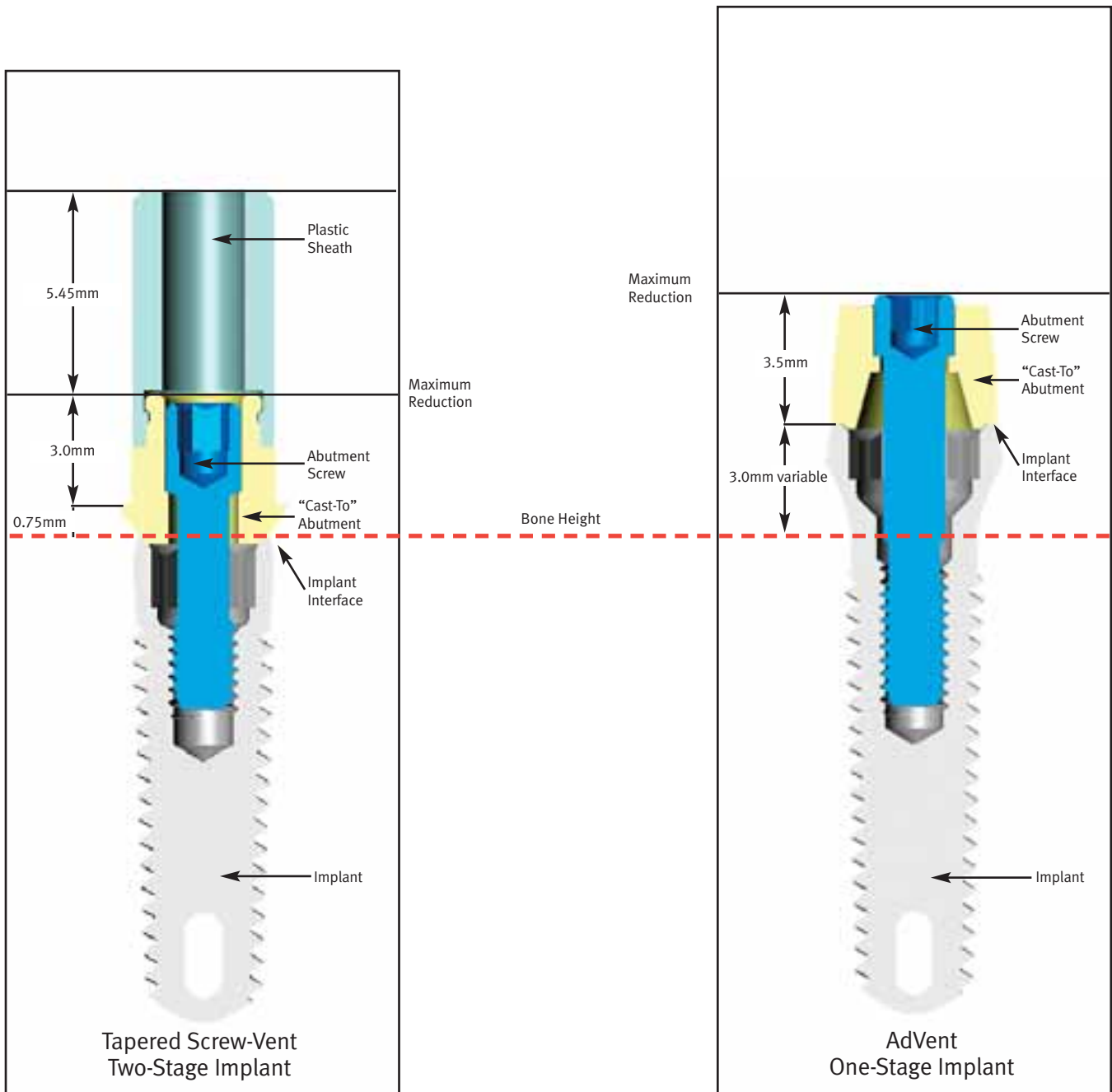



Removing the healing components

Unthread the abutment screws with the 1.25mmD Hex Tool. Remove the cast framework from the working cast. Sterilize the components according to standard clinical procedures.

Remove the provisional restoration from the patient's mouth. Unthread the Healing Collars or Surgical Cover Screws with the 1.25mmD Hex Tool. Clean and sterilize the components for placement after the cast framework try-in.



Trying in the metal framework

To determine a passive fit, a distal gold component incorporated within the cast metal framework is attached to its corresponding implant with an Abutment Screw [MHLAS]. Finger-tighten the screw with the 1.25mmD Hex Tool. The metal framework is then inspected to verify that no discernable gaps are present between the remaining components and implants. If a gap is present, determine where the framework should be sectioned and follow procedures in **Tapered Abutment Section** on page 68.

Return the framework to the laboratory on the working cast for final processing of the fixed partial denture.



Finishing the final prosthesis

Prepare the metal framework to receive the opaque layer according to routine laboratory procedures. Apply porcelain to the framework and ensure that no porcelain flows inside the screw access channel. Refine the screw access channel within the prosthesis by hand-rotating the Reamer for "Cast-To" or castable Abutments [MRI for NEA3G and NEA4G; PR for AdVent components].

Finish the porcelain and polish any metal margins, taking care to not alter the area which interfaces with the implant. Seat the finished prosthesis on the working cast and send it to the clinician for final delivery.



Delivering the final prosthesis

Remove the provisional restoration and/or healing components from the patient's mouth.

Sterilize and seat the finished prosthesis onto the implants. Thread the abutment screws into the implants with the 1.25mmD Hex Tool. Torque the screws to 30 Ncm with a calibrated torque wrench.

Confirm the fit, contour and occlusion of the restoration, and make any needed final adjustments. Seal the screw access channels in each abutment with cotton pellets and composite resin material to complete the contour and esthetics of the restoration.

Provide the patient with oral hygiene instructions prior to release.



Selecting the “Cast-To” Gold Abutment

Fabricate the working cast utilizing one of the procedures mentioned in the transfer section. Non-Engaging “Cast-To” Gold Abutments are for 3.5mmD and 4.5mmD *Tapered Screw-Vent* and *Screw-Vent* Implant platforms [NEA3G and NEA4G]. These component assemblies consist of a non-hexed, gold “Cast-To” abutment body, Abutment Screw [MHLAS] and 3.8mmD press-fit Plastic Sheath [OPS].

A procedure for implant level non-engaging components for the *AdVent* Implant with the 4.5mmD platform can be found in the section on **Immediate Bar Fabrication**.

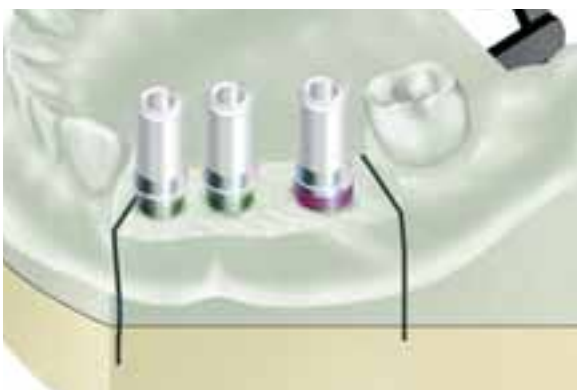

Attaching the abutments and Plastic Sheaths

These abutments are selected in this case due to the limited vertical clearance between the implant platform and the occlusal surface of the opposing dentition. The vertical limitation prevents the use of the Tapered Abutment System.

Carefully seat the assemblies onto the Implant Analogs in the working cast. Thread the abutment screws through the abutment assemblies and into the Implant Analogs with the 1.25mmD Hex Tool. To fully seat the abutments, tighten the abutment screws to 30 Ncm with a calibrated torque wrench.



Trimming the Plastic Sheaths

Visually determine the modifications needed to provide adequate clearance for adjacent and opposing dentition. Consult with the clinician to determine any additional modifications needed for the case design. Section the Plastic Sheaths with a cutting disk to obtain the correct vertical and interproximal clearance. Minor circumferential changes can be made to the gold base to allow the framework to fit within the profile of the desired restoration.



Fabricating the framework pattern

Use wax and/or acrylic burnout resin to incorporate the modified gold base and Plastic Sheaths into the pattern. Build up the final contours of the pattern with crown and bridge wax. Carefully apply a thin layer of wax or burnout resin at the junction of the abutment and the Plastic Sheath to ensure a smooth casting.

An alternative to using the Plastic Sheaths and Abutment Screws:

- Secure the abutments to the Implant Analogs with the Waxing Screws [MTWSD for internal hex implants].
- Lightly lubricate the Waxing Screw.
- Use wax and or acrylic burnout resin and fabricate the framework pattern around the screw and directly to the abutments.



Removing the framework pattern

Create a very thin cut between the components to section the framework. Use wax or burnout resin to lute the sections together. This process is incorporated to relieve the stresses in the framework pattern created by contraction distortion of the wax or resin used in the fabrication of the framework pattern.

Remove the abutment screws with the 1.25mmD Hex Tool then remove the framework pattern from the Implant Analogs.

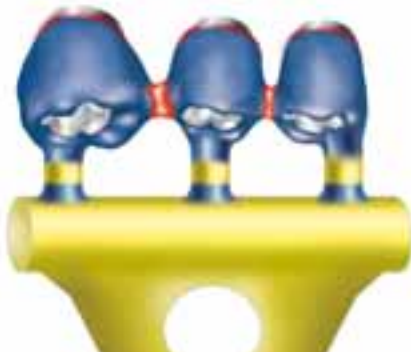

Spruing, casting and divesting of the metal framework

Attach 10-gauge sprue wax to the thickest part of each unit. Add auxiliary sprues and vents to prevent porosity in the casting as needed. Connect the framework to a runner bar then assemble to rubber casting base. Do not use a debubbler when investing the gold or plastic components

When casting to gold components, the casting alloy must not exceed a casting temperature of 2350°F/1288°C. Cast the framework pattern according to conventional techniques utilizing a two-stage burnout, which is standard practice with patterns containing plastic or resin. The burnout temperature should not exceed 1500°F/815°C, with a hold time of no longer than 1 hour. Utilize high noble or noble alloy with a compatible investment material, as described in the manufacturer's guidelines.

Divest the casting; chemical investment removers may also be used with gold components. To ensure that the fitting surface of the incorporated copings are not damaged, protect the abutment interface while blasting the abutment with non-abrasive glass bead. Clean the casting in an ultrasonic unit. Refine the screw access holes within the casting by hand-rotating the Reamer for "Cast-To" or castable abutments [[MRI for NEA3G and NEA4G](#); [PR for AdVent components](#)].



Finishing the metal framework

Remove the soft tissue replica from the working cast to provide visual access to the cast metal frame/implant analog connection. Confirm a passive fit has been achieved.

Secure the finished framework to the Implant Analogs in the working cast and return it to the clinician for try-in.

Hex Tools
1.25mmD Hex Tools for Abutment Screws and Fixation Screws



HX1.25 HXL1.25 THX1.25 THXL1.25 0721

Removal Tool
for Internal Hex Implant Abutments

- 1) Hex-Lock Contour Abutments
- 2) Hex-Lock Abutments
- 3) 20° Angled Abutment Assemblies
- 4) "Cast-To" Gold Abutments
- 5) Core Abutments for PureForm Ceramic System



TLRT2

Removal Tool for 3-piece 20° Angled Abutments

- 1) To remove 20° Angled Abutment Head from the Abutment Connector attached to Internal Hex Implants.



OHRT

Torque Wrenches and Inserts



TW30

30 Ncm Torque Wrench used to tighten all components and screws attaching directly into the implant.



TW1.25



TW20

20 Ncm Torque Wrench used to tighten screws attaching directly into an abutment.



TW1.25L

Reamers for "Cast-To" or Castable Components



Reamer for Copings
PR



Reamer for HLA and NEA "Cast-To" Series
MRI

Cap Attachment Instruments - CAI



Mandril for Castable Ball Pattern



Nylon Liner Insertion Tool



Nylon Liner Reaming Tool

Cap Attachment System - CAS



Locator Core Tool - LOCCT2



Locator Torque Wrench Insert Driver, 15mmL - LOCTW15



Locator Torque Wrench Insert Driver, 21mmL - LOCTW21



Dolder Gold Bar System - DGB



Round Gold Bar System - HGB

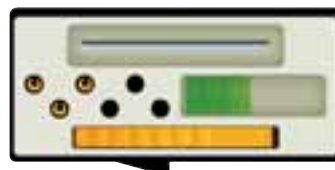

Hader Clip Bar System - BS1



**For more information about our Products, Professional Programs
and Educational Opportunities, contact us:**

1900 Aston Avenue
Carlsbad, CA 92008-7308, USA
In the U.S. 800 854 7019

To fax an order 888 225 2483
Outside the U.S. +1 760 929 4300
Australia +61 (0)2 9950 5444 or 1 800 241 916
Canada +1 905 567 2073 or 1 800 265 0968

France +33 (0)1 45 12 35 35
Germany +49 (0)761 4584 722/723
Israel +972 (0)3 6124242
Spain +34 93 846 05 43

To receive our eNews visit us at http://www.zimmerdental.com/news_eNewsletterSignUp.aspx



www.zimmerdental.com